

What is HVAC ?



Heating



Ventilation



Air Conditioning

1. Heating

The Purpose of Heating ?

3



Method of getting heat

1. Nature
2. Mechanical system

2. Ventilation

The PURPOSE OF VENTILATION ?

4

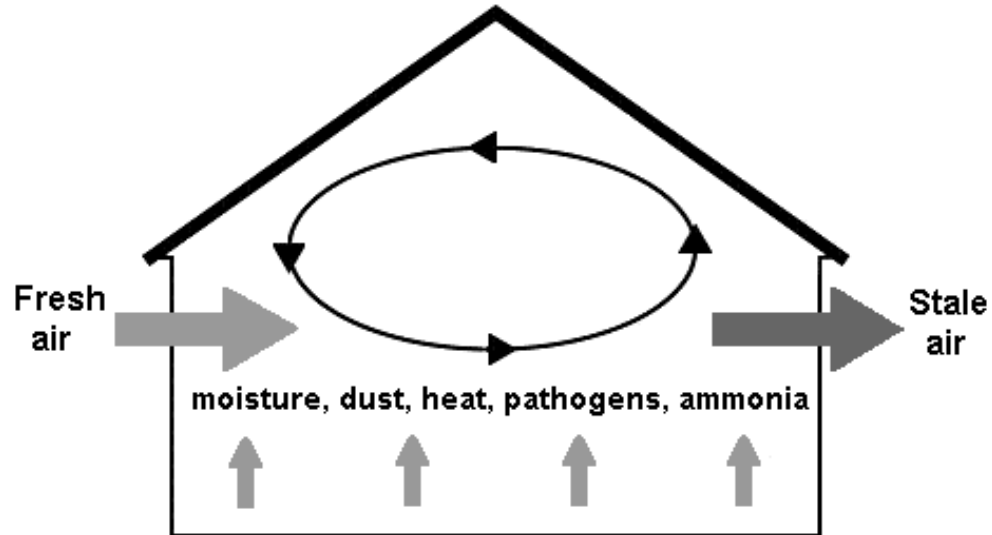

3. Air Conditioning

Purpose of air conditioning?

5

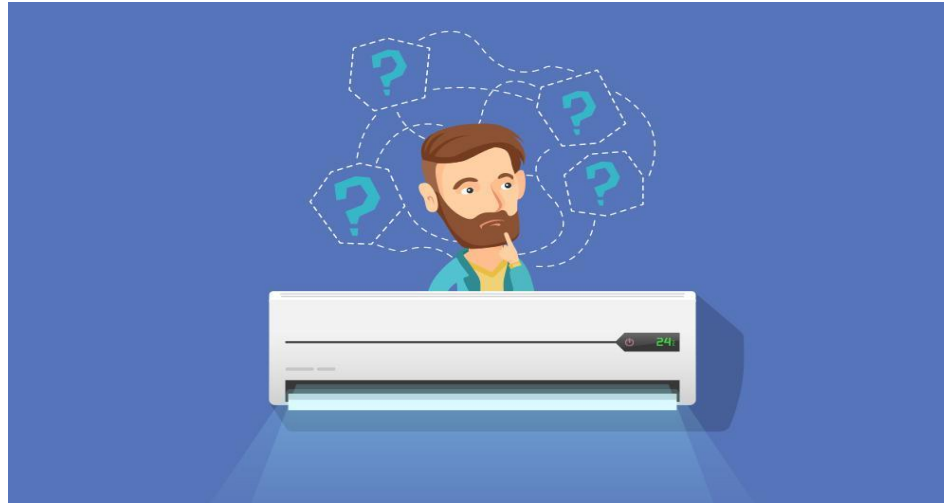

PURPOSE OF HVAC SYSTEMS

6



HUMAN COMFORT



Functions Of HVAC Systems

1. Control of air temperature

7

(ASHRAE) has established standards comfortable that when the air temperature is between 20-24°C

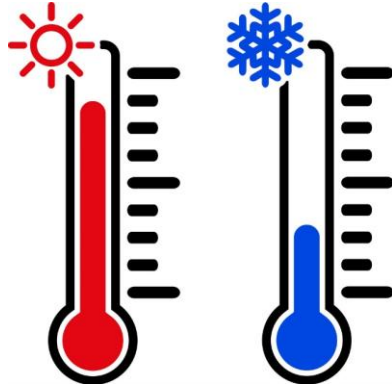

Heating



Cooling

2. Control of air humidity

8

- Most people (90%) are comfortable when the air humidity is 50%.
- Also there are specific applications require specific humidity



3. Control of air cleanliness (Filtration)

4. Control of air motion (Air distribution)

9

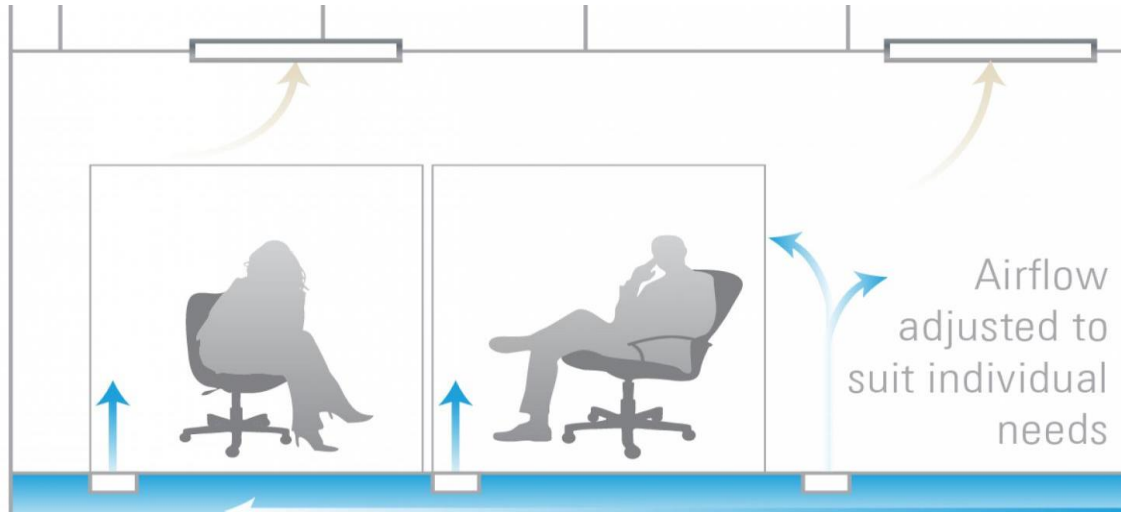

Ventilation

Types of Mechanical ventilation systems

10

1. Nature Ventilation

2. Mechanical Ventilation

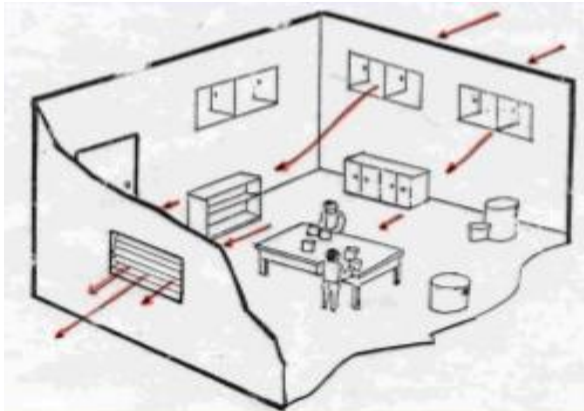

Natural Ventilation

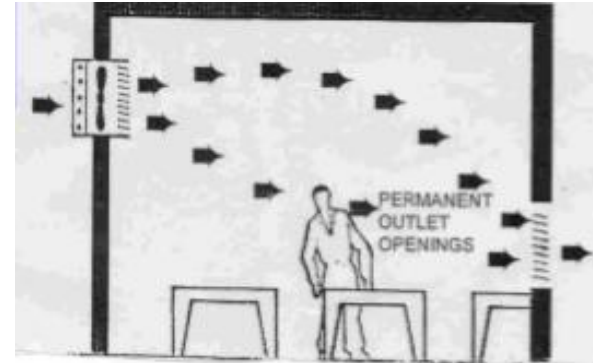

Mechanical Ventilation

(State of pressure for different applications)

11

CENTRAL VENTILATION STRATEGIES

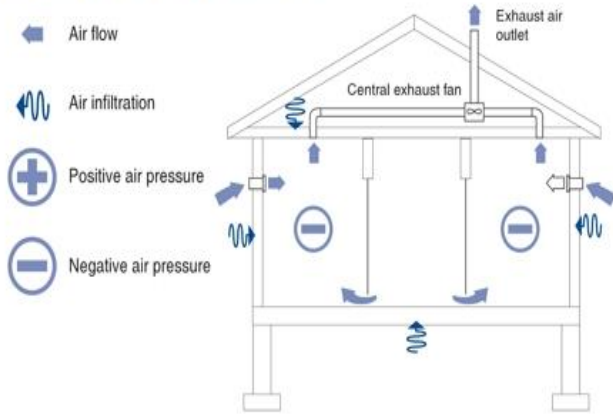

Exhaust ventilation

$$EA > FA$$

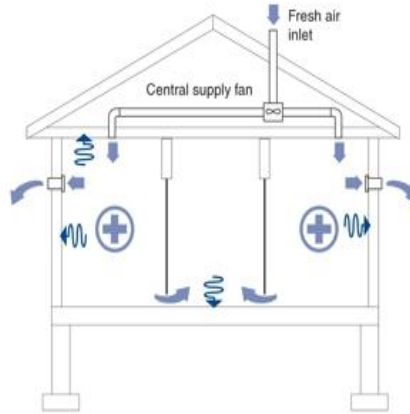

Supply ventilation

$$EA < FA$$

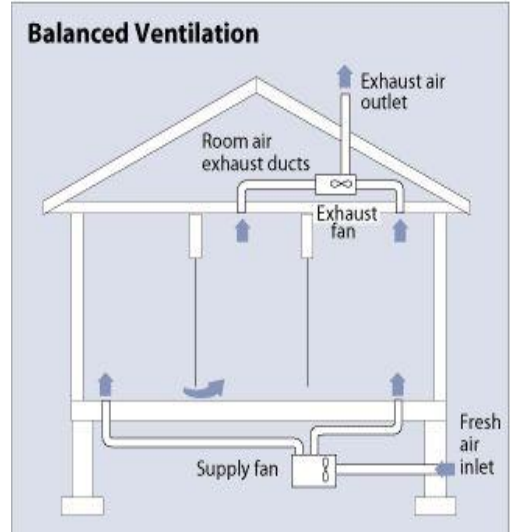

$$EA = FA$$

EA: exhaust air
FA: fresh air

Applications of Ventilation System

12

- **Kitchens**
- **Toilets**
- **Car Park at Basements**
- **Factories**
- **Chemical Industries**
- **Pharma Industries ,etc.**

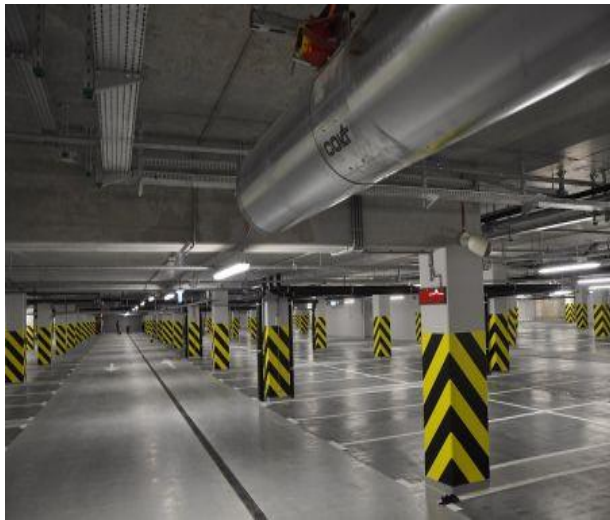

Functional Requirements for Effective Building Ventilation

14

- 1. ACH should be optimum**
- 2. Supplied air must be fresh and free of dust and Bacteria (filtration)**
- 3. If possible ,its better for outlet be near roof level and inlet opening near floor level**
- 4. Should the humidity maintained on the correct level**
- 5. Take into account the outside temperature effect on the inside temperature**

Steps of selection of ventilation system

15

- 1. Understand the existing processes in place**
- 2. Get ACH for the place**
- 3. Get the required CFM**
- 4. Making design for ducts routing**
- 5. Get the static pressure**
- 6. Select the suitable fan**

How to calculate CFM for ventilation ?

$$\text{Required CFM} = \frac{\text{Volume of Room (ft}^3\text{)} \times \text{ACH}}{60}$$

ACH Tables

Air Changes Per Hour (ACH) Table

This table provides suggested air changes per hour (ACH) under normal conditions based on our extensive experience.

Assembly rooms	4 - 8	Hairdressing salons	10 - 15
Bakeries	20 - 30	Hospitals - sterilizing	15 - 25
Banks/Building Societies	4 - 8	Hospitals - wards	6 - 8
Bathrooms	6 - 10	Kitchens - domestic	15 - 20
Bedrooms	2 - 4	Kitchens # - commercial	30minimum
Billiard Rooms *	6 - 8	Laboratories	6 - 15
Boiler Rooms	15 - 30	Laundrettes/Laundromats	10 - 15
Cafes and coffee bars	10 - 12	Laundries	10 - 30
Canteens	8 - 12	Lavatories	6 - 15
Cellars	3 - 10	Lecture theatres	5 - 8
Changing Rooms Main area	6 - 10	Libraries	3 - 5
Changing Rooms Shower area	15 - 20	Living rooms	3 - 6
Churches	1 - 3	Mushroom houses	6 - 10
Cinemas & theatres *	10 - 15	Offices	6 - 10
Club rooms	12 minimum	Paint shops (not cellulose)	10 - 20
Compressor rooms	10 - 20	Photo & X-ray darkrooms	10 - 15
Conference rooms	8 - 12	Public house bars	12 minimum
Dairies	8 - 10	Recording control rooms	15 - 25
Dance halls	12 minimum	Recording studios	10 - 12
Dental surgeries	12 - 15	Restaurants	8 - 12
Dye works	20 - 30	Schoolrooms	5 - 7
Electroplating shops	10 - 12	Shops and supermarkets	8 - 15
Engine rooms	15 - 30	Shower baths	15 - 20
Entrance halls & corridors	3 - 5	Stores & warehouses	3 - 6
Factories and workshops	8 - 10	Squash courts	4 minimum
Foundries	15 - 30	Swimming baths	10 - 15
Garages	6 - 8	Toilets	6 - 10
Glasshouses	25 - 60	Utility rooms	15 - 20
Gymnasiums	6 minimum	Welding shops	15 - 30

* Increase by 50% where heavy smoking occurs or if the room is underground.

Some commercial kitchens may require higher ventilation rates, based on cooking equipment in use.

ASHRAE Tables

APPENDIX

18

Table 7.1 Design Parameters—Hospital Spaces (Continued)

Function of Space	Pressure Relationship to Adjacent Areas (n)	Minimum Outdoor ach	Minimum Total ach	All Room Air Exhausted Directly to Outdoors (j)	Air Recirculated by Means of Room Units (a)	Design Relative Humidity (k), %	Design Temperature (l), °F/°C
Continued care nursery	N/R	2	6	N/R	No	30–60	72–78/22–26
Labor/delivery/recovery (LDR) (s)	NR	2	6	NR	NR	Max 60	70–75/21–24
Labor/delivery/recovery/postpartum (LDRP) (s)	NR	2	6	NR	NR	Max 60	70–75/21–24
Newborn nursery suite	NR	2	6	NR	No	30–60	72–78/22–26
Nourishment area or room	NR	NR	2	NR	NR	NR	NR
Patient corridor	NR	NR	2	NR	NR	NR	NR
Patient room	NR	2	4 (y)	NR	NR	Max 60	70–75/21–24
PE anteroom (t)	(e)	NR	10	NR	No	NR	NR
Protective environment room (t)	Positive	2	12	NR	No	Max 60	70–75/21–24
Toilet room	Negative	NR	10	Yes	No	NR	NR

Minimum outdoor >>>> minimum fresh air
Minimum total >>> minimum supply air

Calculation of static pressures

19

Uses of pressure loss charts

- i. Equal friction method**
- ii. Equal velocity method**

- 1. By recommended velocity from ASHRAE 2007**
- 2. And calculated CFM**
- 3. Get Pst and make it constant along the system**
- 4. Get main Diameter**
- 5. Then for different flowrates $Q=V \times A$ get duct sizing**

Recommended air velocities (f/m)

	Recommended velocity		
	Residence	Schools, public areas	Industrial areas
Outside air inlet	500	500	500
Fan outlet	700	800	1000
Main ducts	700-900	1000-1300	1200-1800
Branch duct	500-600	500-600	800-1000

Pressure loss chart

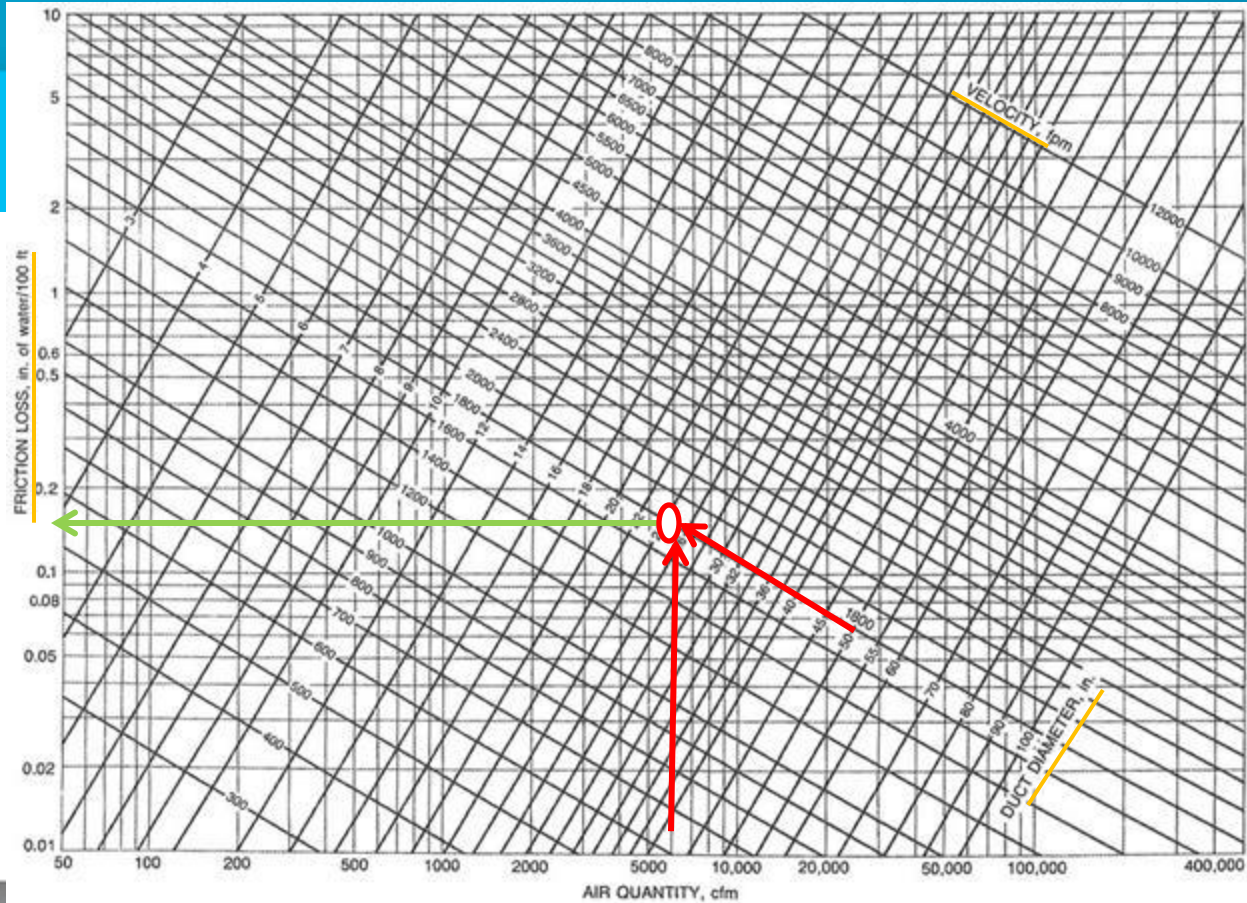

Variables are required in selection of fans

22

$$\checkmark \text{ CFM} = \frac{\text{volume} \times \text{ACH}}{60} = \mathbf{V \times A}$$

A: Area

H: Height

ACH: Air change per hour

✓ **Type of application**

✓ **Static pressure**

Fans

23

- **Any device that produces a current of air by the movement of the blades can be called a fan.**
- **Fans used either in FCU ,AHU ,Supply fan or Exhaust fan**

Fans Types

24

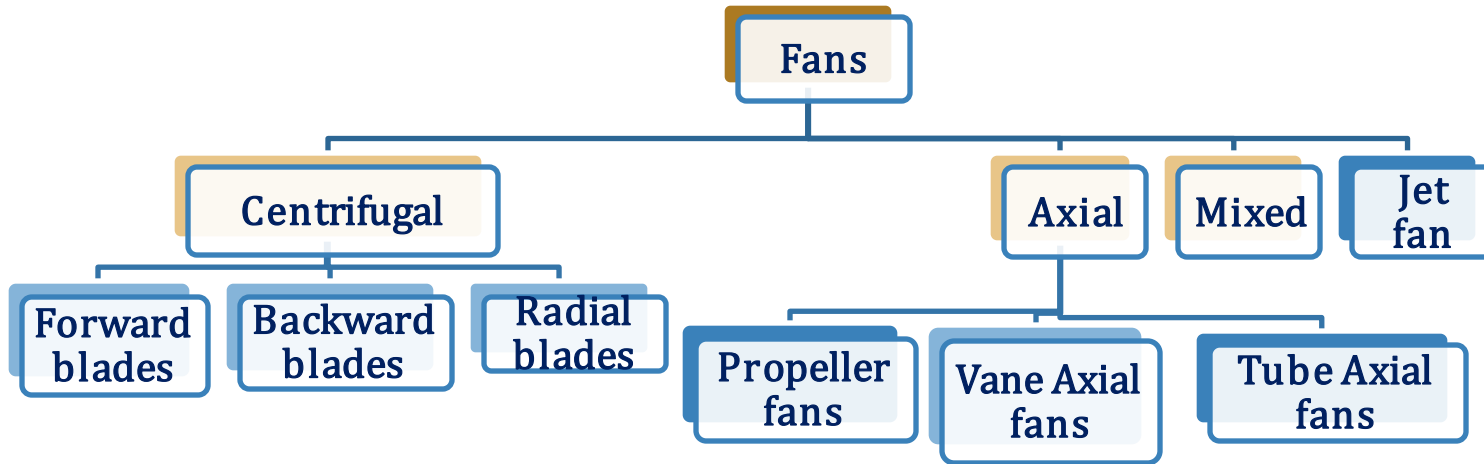

Fan/Blower Blades Types

25

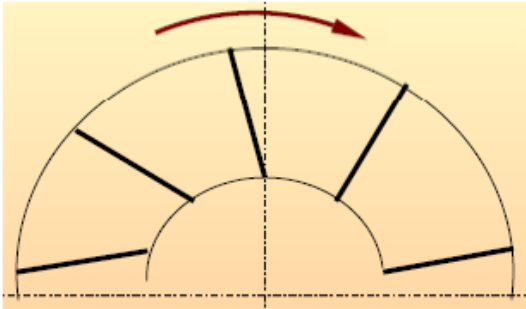

Constant thickness blades

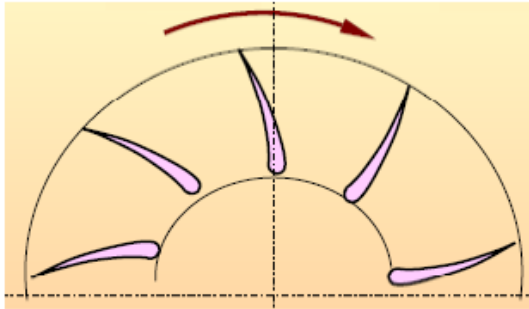

Aerofoil blades

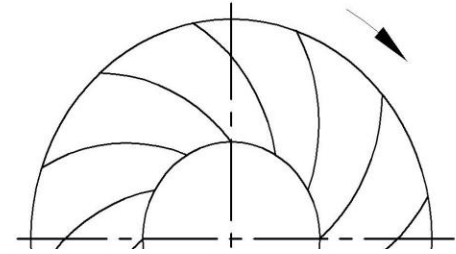

Curved blades

Fan efficiencies

26

Type of fan	Peak Efficiency Range
Centrifugal Fans	
Airfoil, backward curved/inclined	79–83
Modified radial	72–79
Radial	69–75
Pressure blower	58–68
Forward curved	60–65
Axial fan	
Vane axial	78–85
Tube axial	67–72
Propeller	45–50

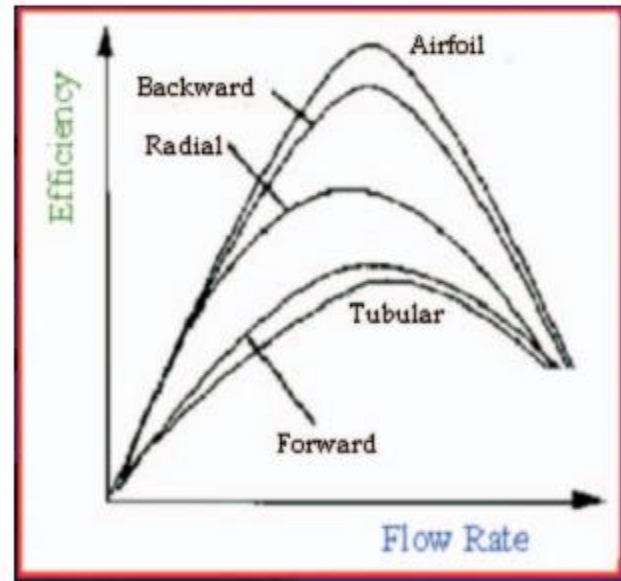

Series and Parallel Operations for fans

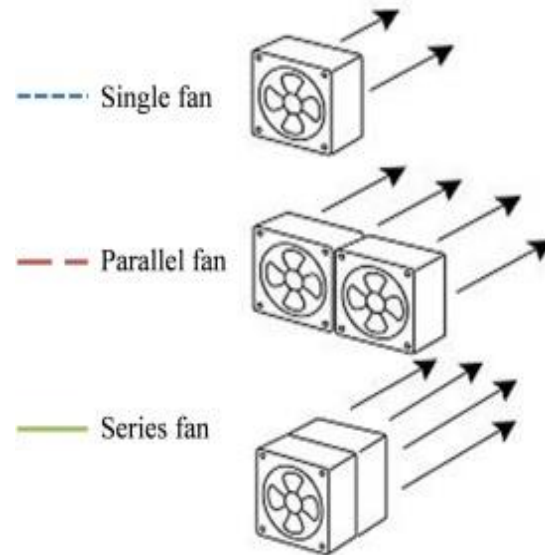
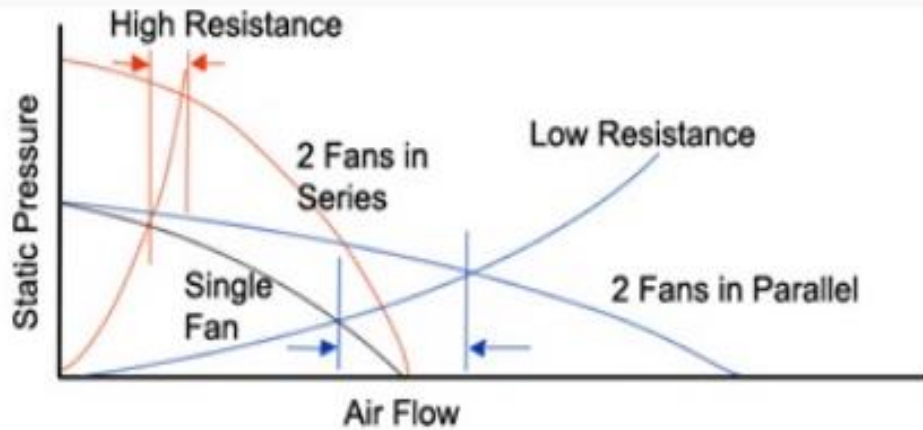

Centrifugal fan

28

- It could be catalogued by:
 1. Drive type (Belt drive OR Direct drive)
 2. Blade type either it (forward or backward or Radial)

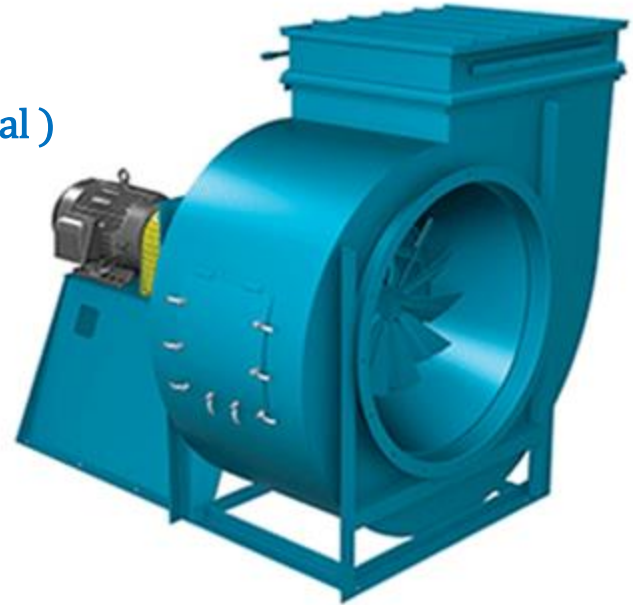

Drive type (Belt drive OR Direct drive)

29



Direct



Belt

Blade type either it (forward or backward or Radial)

30

a) Forward blades

- Common with FCU
- Constant or curved blade shape
- Medium efficiency

b) Backward blades

- Common with AHU
- Constant, curved or airfoil blade shape
- Higher efficiency
- Efficient than forward because change in static pressure don't overload the' motor "non-overloading'
- Low noise

c) Radial blades (straight blades)

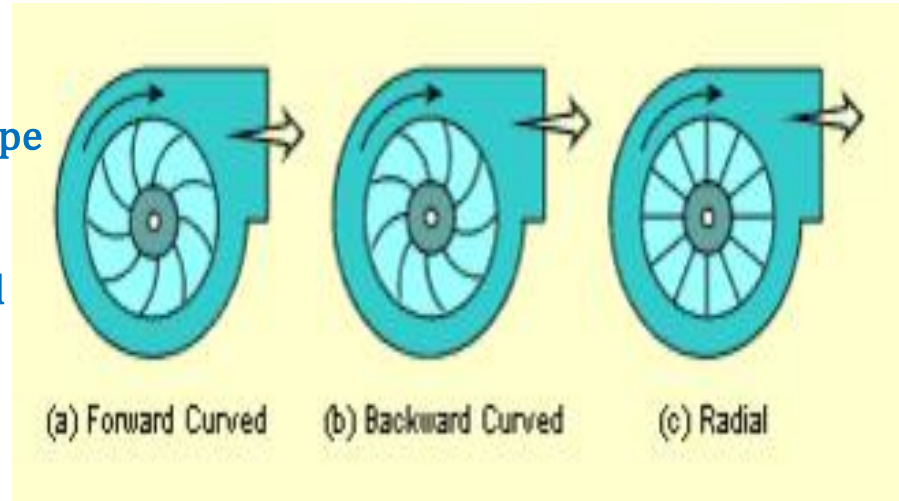



Axial fan

31

- a) Propeller fans
 - Less efficient, low airflow
 - Not ducts
 - Used in split and window types AC
 - Low static pressure
 - b) Vane Axial fans
 - Higher efficient
 - Medium static pressure
 - c) Tube Axial fans
 - Higher speed than propeller so high airflow
- Constant or aerofoil blade shape

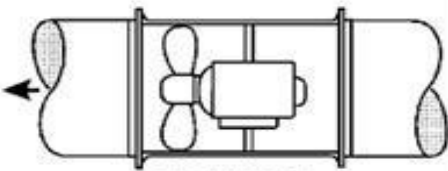
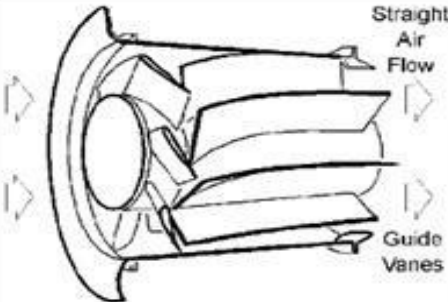
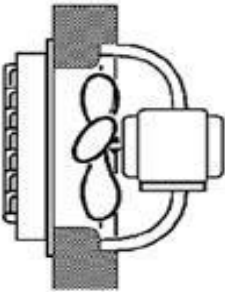

Tube Axial	Vane Axial	Propeller
		
 <p data-bbox="401 776 556 794">TUBEAXIAL FAN</p>	 <p data-bbox="1097 547 1174 620">Straight Air Flow</p> <p data-bbox="1097 776 1174 820">Guide Van</p> <p data-bbox="852 871 1039 889">VANEAXIAL FAN</p>	 <p data-bbox="1199 663 1373 729">PROPELLER FAN Belt Drive or Direct Connection</p>

Mixed fan

33

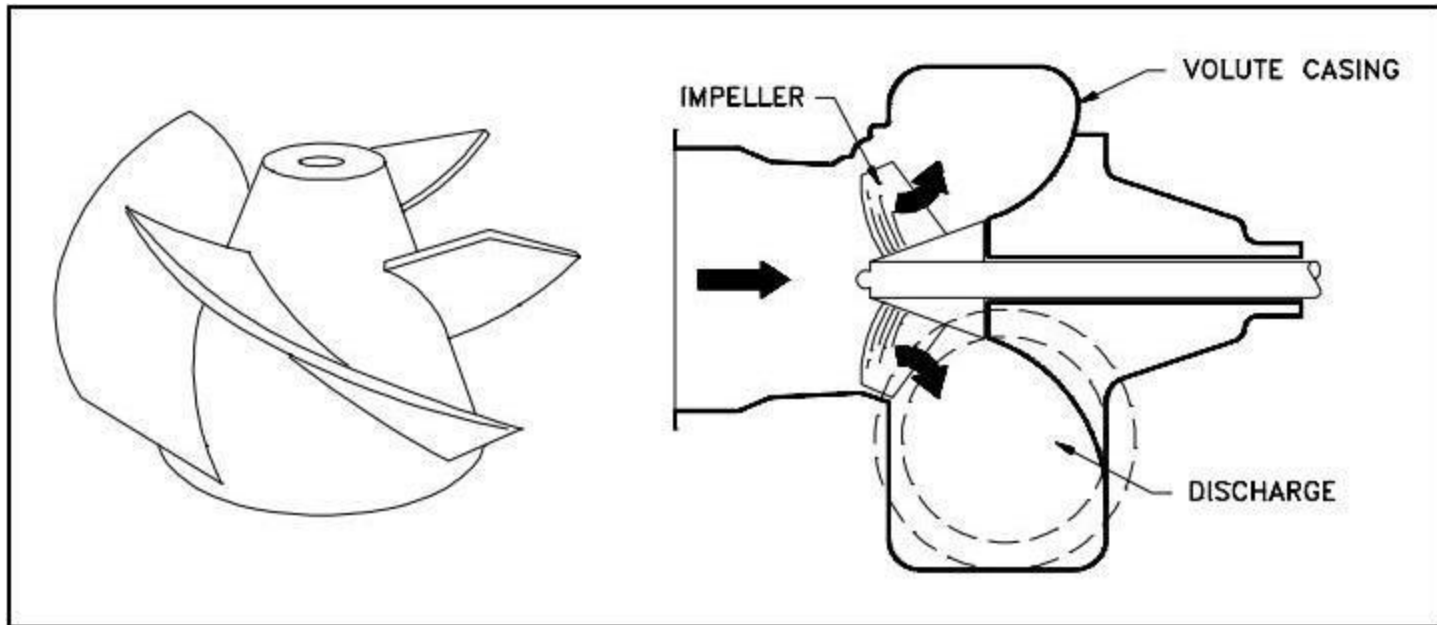

Jet fan

Types of jet fans:



Axial Jet Fan

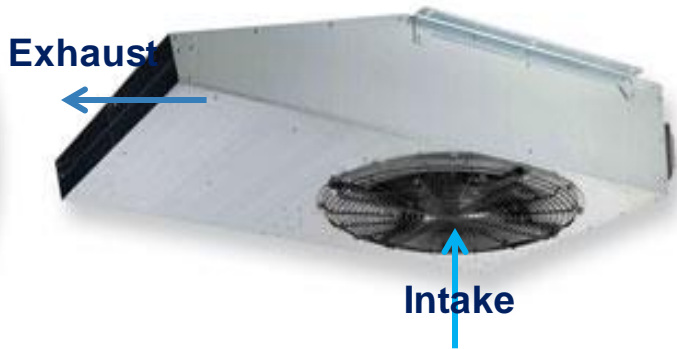

Centrifugal Induction
Jet Fan

Fans Installation

35

1. Inline ducted

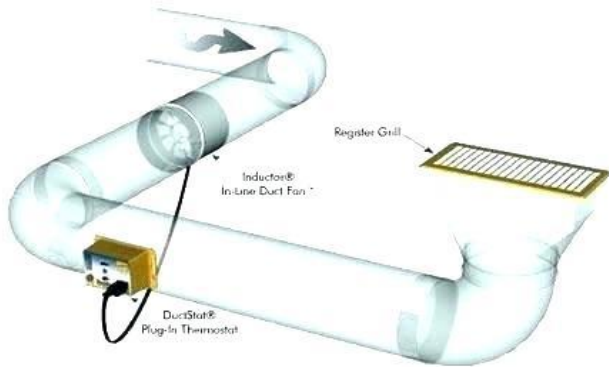

2. Rooftop

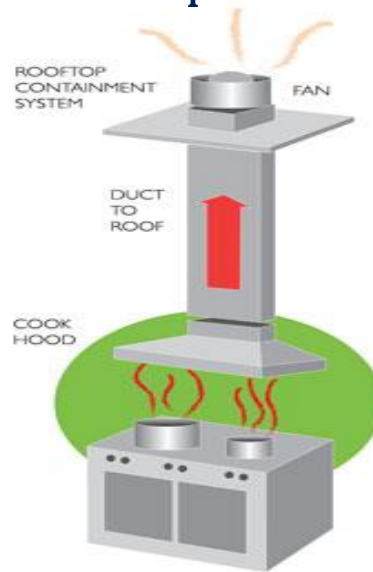

3. Wall mounted



Fans being exist for more safety on the system

Pressurized fan

36

Its Important of exciting of those system

1. Stair Pressurization Fan (SPF)

- When there's a fire, clean outside air is forced by a Stair Pressurization Fan into a stairwell.
- The pressurization is used to push back on smoke, keeping the smoke out of the escape route.
- The pressurized air helps people escape the fire and firefighters battle the fire.

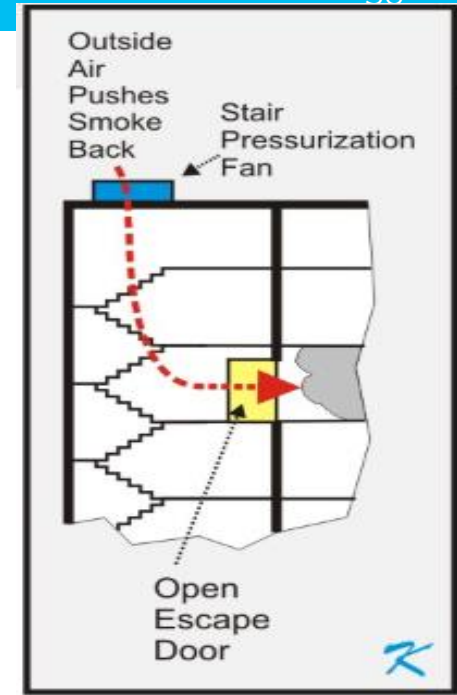

Smoke fan

37



Car Park Ventilation System

38

1. System components

1. Jet fan
2. Ducted system (Supply/Exhaust)
3. Louvers

1. Jet fan

39

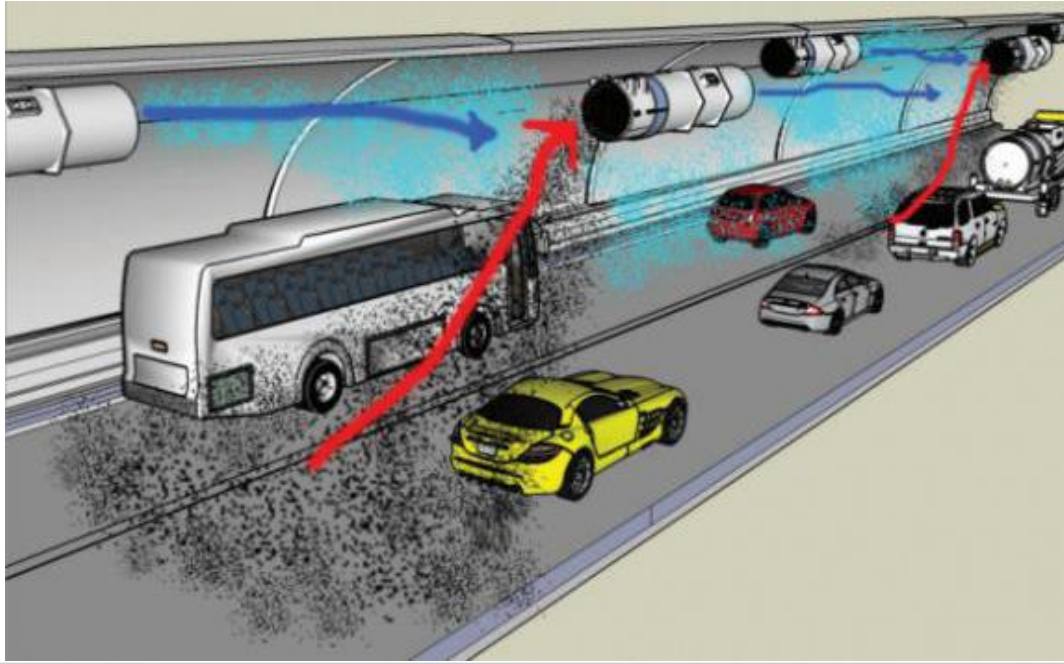

2. Ducted system

40

- a) Supply ducts
- b) Exhaust ducts
- c) Grills

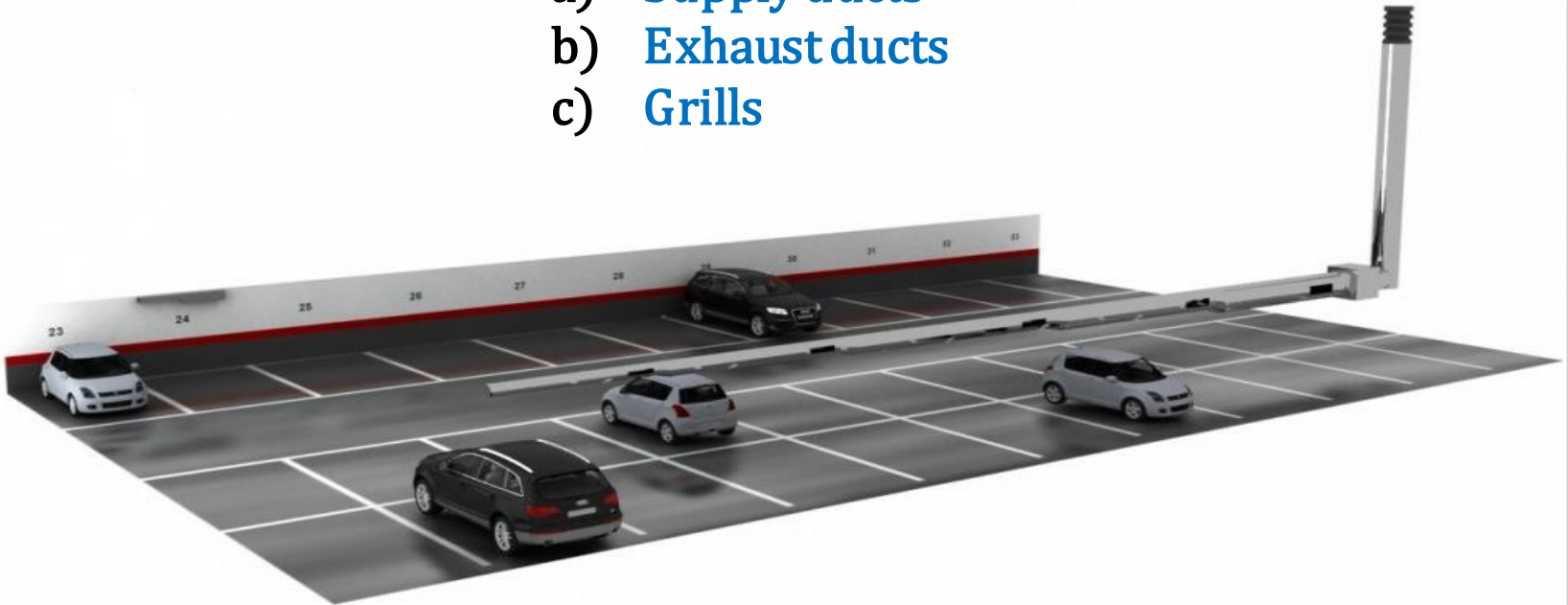

3. Louvers

41



2. Steps for designing the mechanical ventilation ⁴²

1. Calculation of airflow rate (CFM) for jet fan
 - A Computational Fluid Dynamics (CFD) analysis is often required to prove and further refine the design.
2. Selection of supply, exhaust systems based on several parameters (Ducted system)

$$\text{CFM)}_{\text{exh}} = \frac{\text{Volume of Room (ft}^3\text{)} \times \text{ACH}}{60}$$

As car park should be negative pressure (ASHREA) so

$$\text{CFM)}_{\text{fresh}} \cong 0.85 \text{CFM)}_{\text{exh}}$$

3. Divide total CFM to a number of fans then select them
4. Design Coordination

Design Coordination



Fig1 (a) preferred natural path

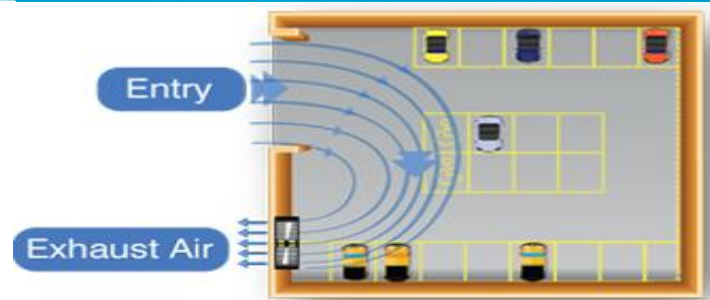

Fig1 (b) natural air path to be avoided

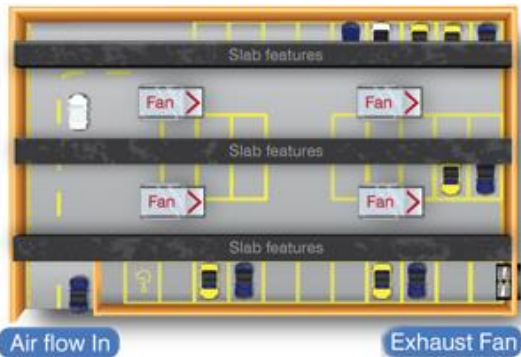

Fig 2(a). Fan's air movement parallel to beams is most effective

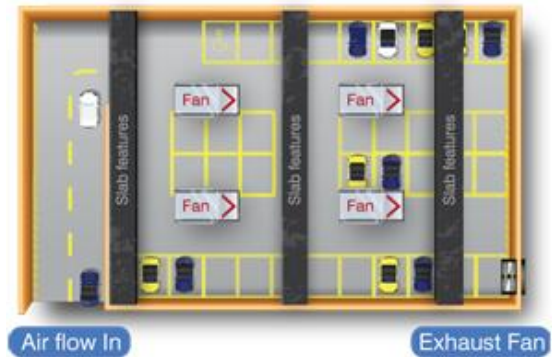

Fig 2(b). Beams is less effective

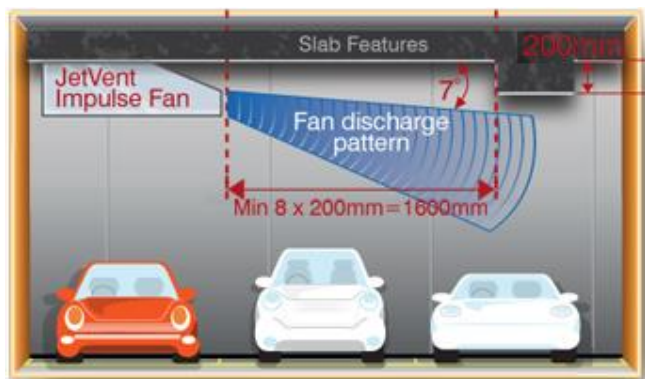

Fig 3(a). Obstruction too close

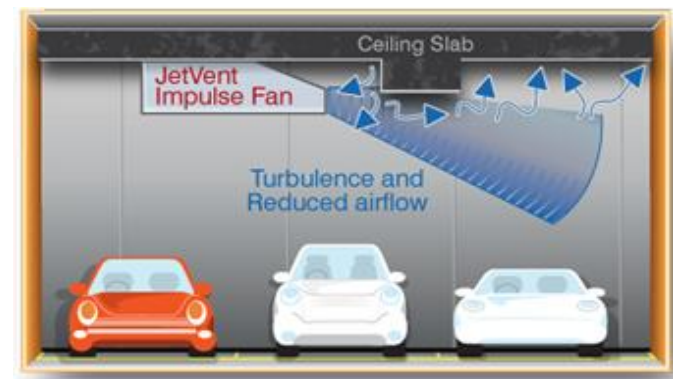
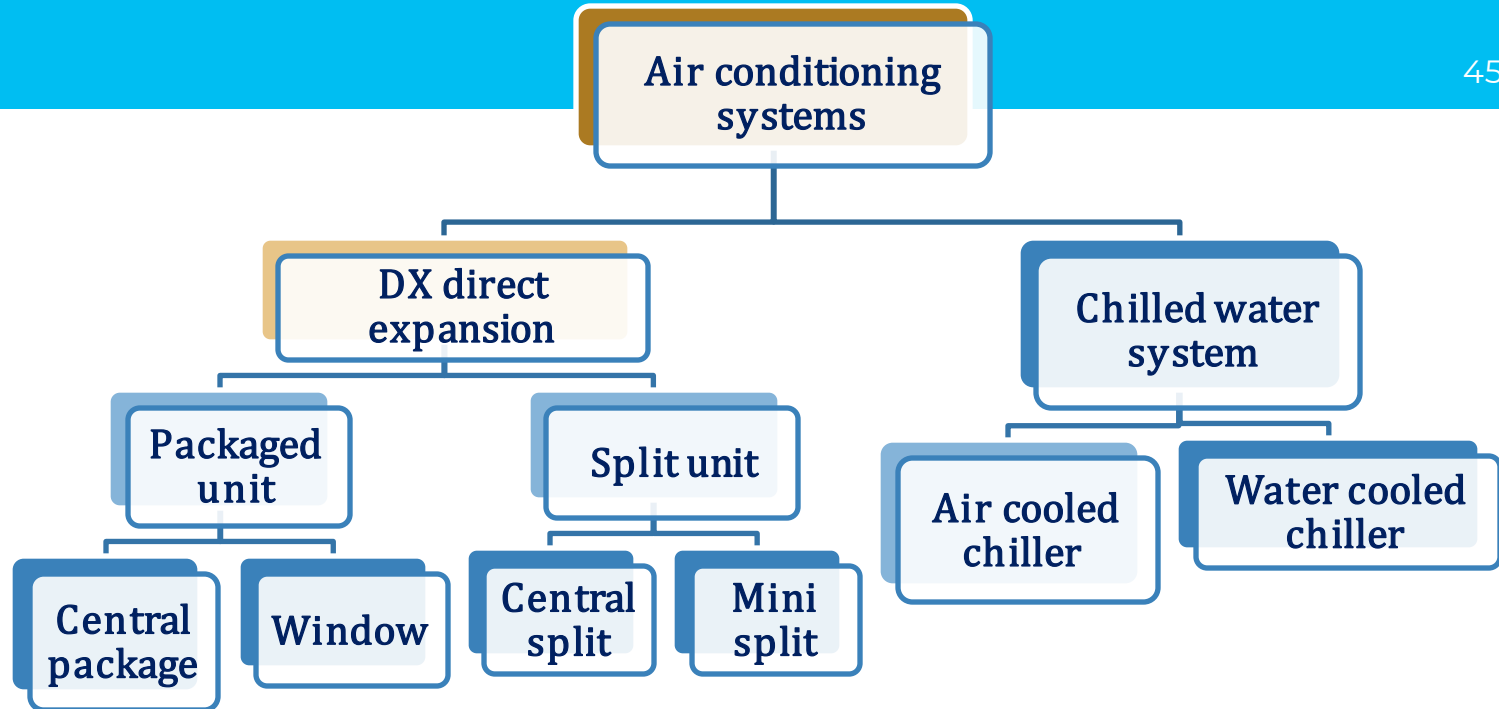

Fig 3(b). Obstruction out of the way



Chilled water System Components

46

- Chillers
- **Air Handling Unit**
- Fan Coil Units
- Pumps
- Cooling Tower in case of water cooled chiller.

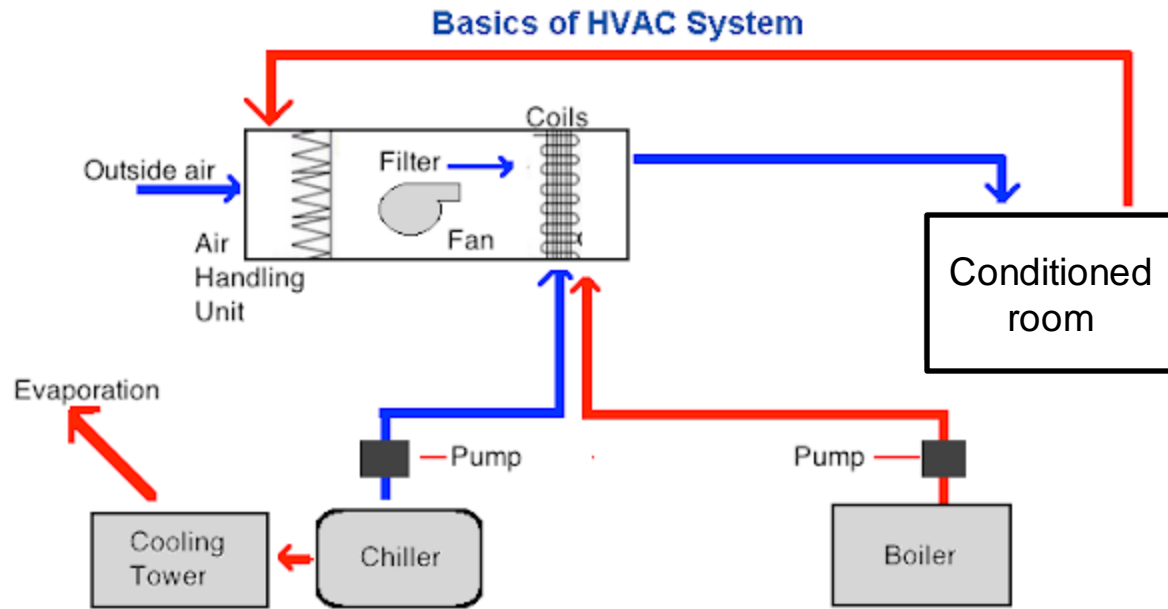

AHU

Purpose of an air handling system

48

The function of the AHU is take in outside air, re-condition it and supply it as fresh air to a building.



Operation For AHU

49

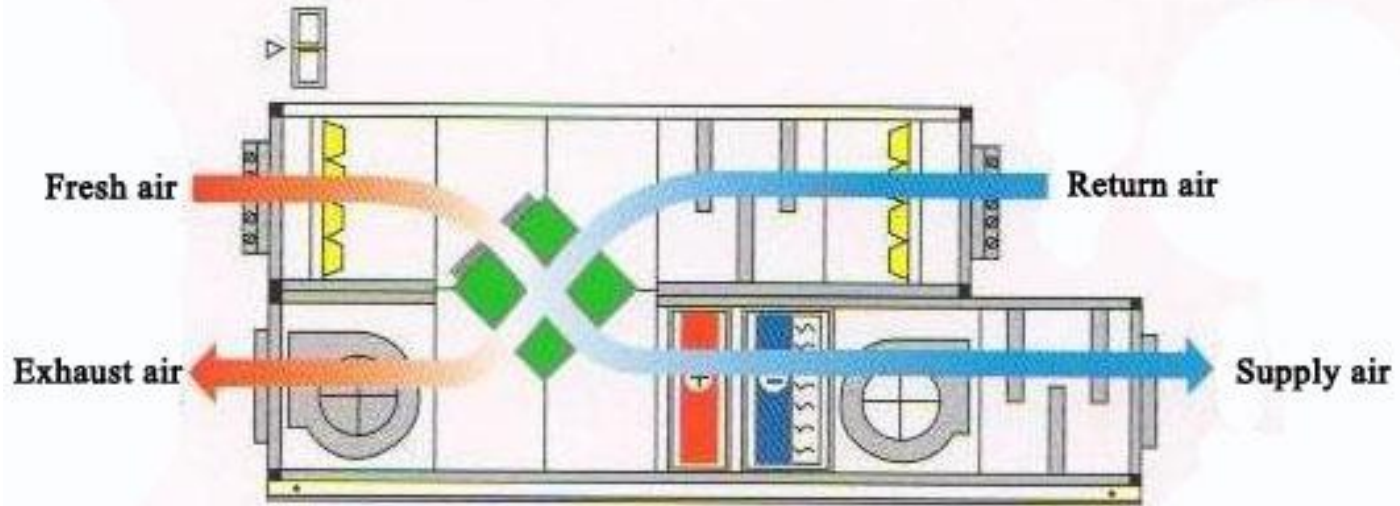



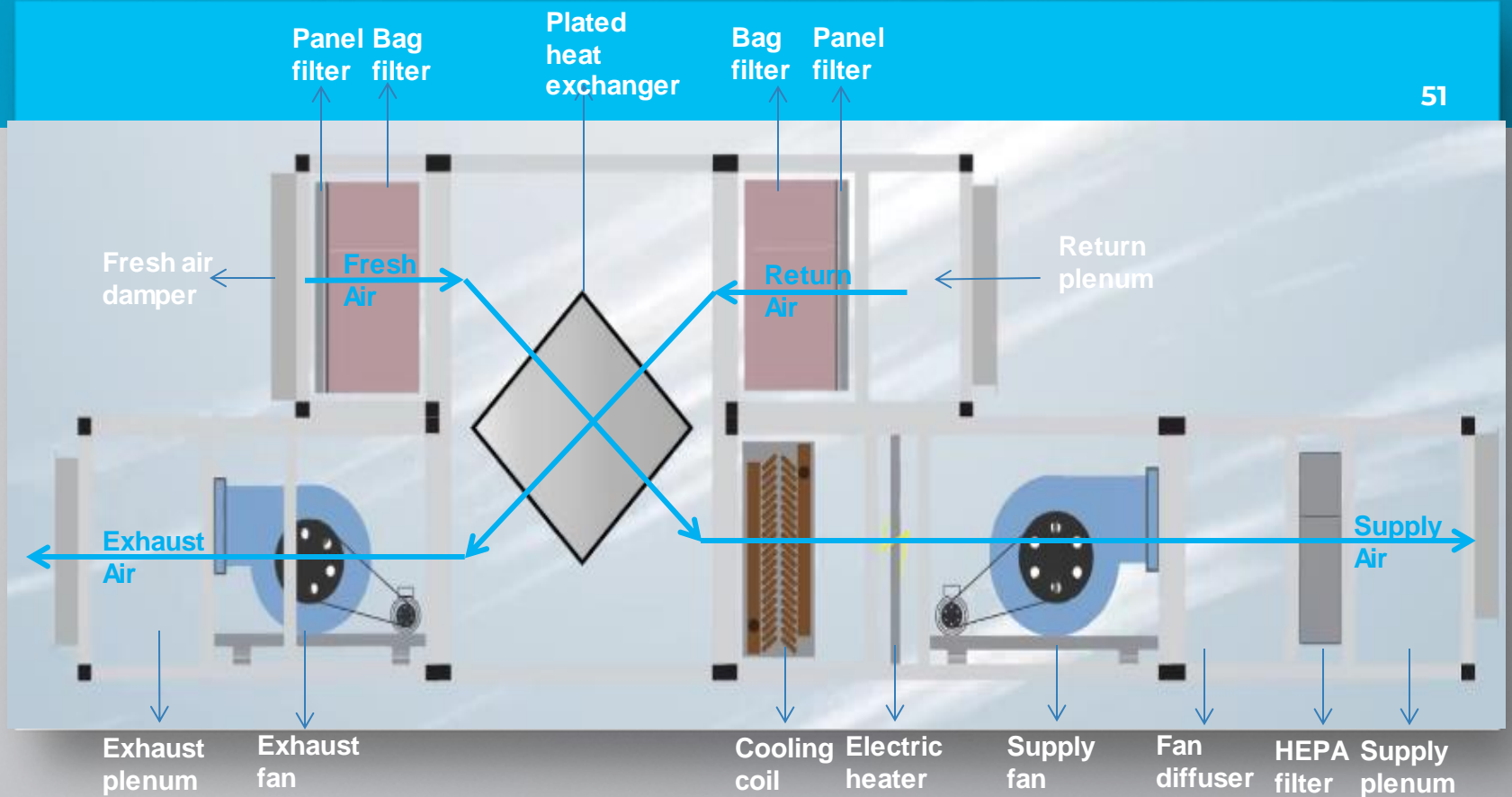

Components OF AHU

52

1. Fresh air damper
2. Mixing box
3. Filters
4. Heat exchanger
5. Cooling coils
6. Heating coils
7. Supply fan
8. Fan diffuser
9. HEPA filter
10. Sound attenuator
11. Supply plenum

1. Air damper

53

A damper is a valve or plate that stops or regulates the flow of air inside a duct, chimney, air handler

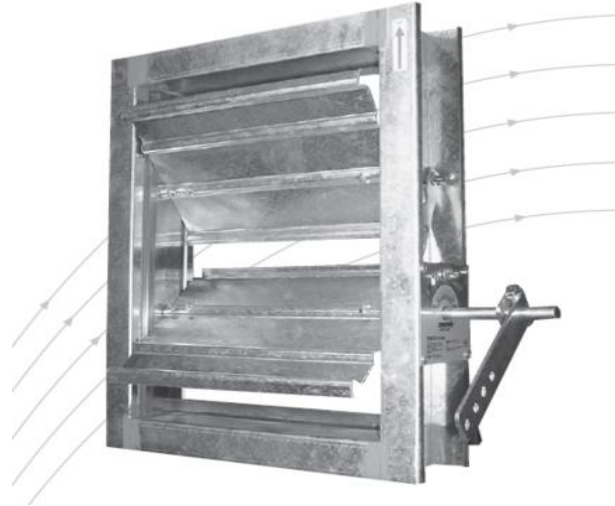

2. Mixing box

54

Mix the return air and fresh air from outside for re-sending into the air-conditioned

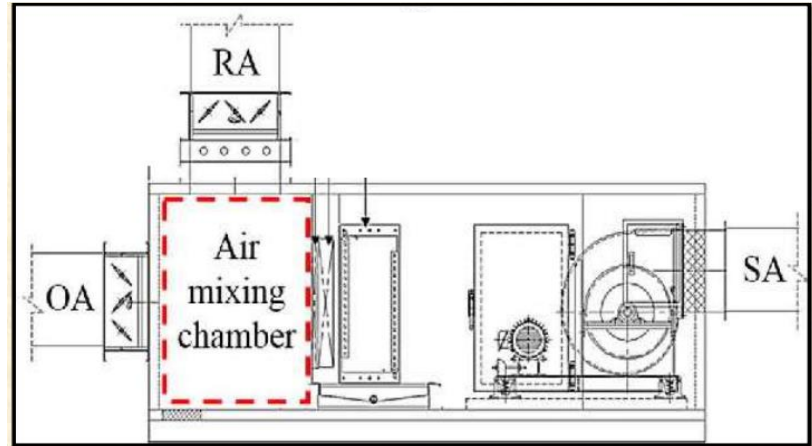
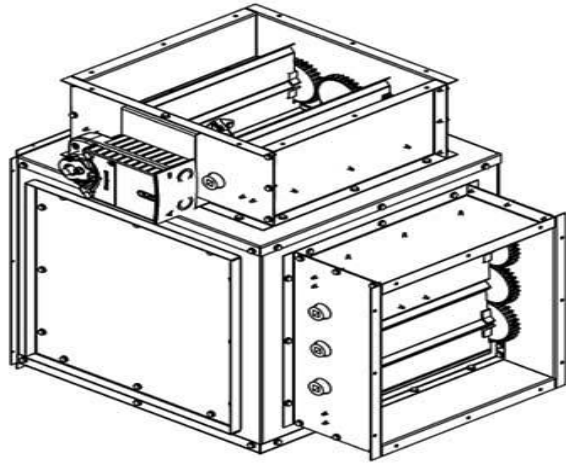

3. Filters types

55

Its one of the important parts of AHU it removes dirt, dust and smoke

1. Standard Filters

- i. Coarse Filters ..G1,G2,G3,G4 It includes
 - a. Mesh Filters (Aluminum Washable)
 - b. Pre Filters(Panel Filters/Primary Filters)



- ii. Fine filters (M5,M6 ,F7,F8,F9)
(Bag Filters/Secondary Filters)



2. Absolute Filters

56

They are super efficient, they meet standard that remove at least 99.7% of airborne particles

- i. **Efficient Particulate Air Filters (EPA) E10,E11,E12**
- ii. **High Efficient Particulate Air Filters (HEPA) H13,H14**



Classification of filters, filter properties and typical examples of use

The filter group	The level of filtration	The examples of separated particles material	Recommendation for application of air filters
G Filters for coarse dust particles Efficient for particles $\geq 10 \mu\text{m}$ EN 779	G1 G2	<ul style="list-style-type: none"> • Leaves • Insects • Textile fibres • Sand • Flying ash • Mist • Hair 	Only for simplest application (e.g. protection against insects)
	G3 G4	<ul style="list-style-type: none"> • Flower pollen • Pollen • Fog 	<ul style="list-style-type: none"> • Waste air of painting boxes and kitchens • Protection against the pollution of air conditioning and compact instruments (e.g. window air conditioning, fans) • Pre - filters for the filtration classes F7 and F8(it is necessary only for heavy polluted input air) • Pre filters and circulation filters for public protection equipments

<p>F</p> <p>Filters for fine dust.</p> <p>Efficient for particulates $\geq 1 \mu\text{m}$</p> <p>EN 779</p>	M5	<ul style="list-style-type: none"> • spore • Cement dust • Particles creating stain or dust sedimentation 	<ul style="list-style-type: none"> • Entering filters for the areas with low demand(e.g. workshops,storages,garage) • Pre-filters for the filtration class F8 and F9.
	M6	<ul style="list-style-type: none"> • Bacterium • Embryo on the carrying parts • 	<ul style="list-style-type: none"> • The entering filters for the area with low demand(e.g. selling areas,specific production area) • Pre-filters for the class filtration F9 and E10 • Filters for waste air for heat exchanger and recuperator
	F7 F8	<ul style="list-style-type: none"> • Accumulated carbon black • So called dust going through lung • • 	<ul style="list-style-type: none"> • Circulating filters in air conditioning • End filters in air conditioning pro average request e.g. shops,offices and specific production areas. • Pre filters for the filtration class E11 and E12.
	F8 F9	<ul style="list-style-type: none"> • Tobacco smoke (roase fractions) • Metal oxide smoke(soarse fractions) • Oil smoke • 	<ul style="list-style-type: none"> • The end filters in air conditioning for higher requests e.g. offices, workshops, telecommunication centres, laboratories etc. • Outside air equipments in hospitals • Digital phone exchanges • Pre-filters for the filtration class H13 and H14 • Pre-filters for adsorbable filters(e.g. filters with active carbon) • Pre-filters in pharmacy

4. Heat exchanger

59

What is a heat exchanger?

A device used to transfer (exchange) thermal energy between exhaust air and fresh air.

What is The main function of a heat exchanger?

It is to increase the energy efficiency of a cooling system by transferring heat ,thus reducing energy bills.

Types of heat exchangers.

1. Plate heat exchangers

60

Heat exchanger where heat is transferred from the flow of exhaust air to the incoming air fresh air.



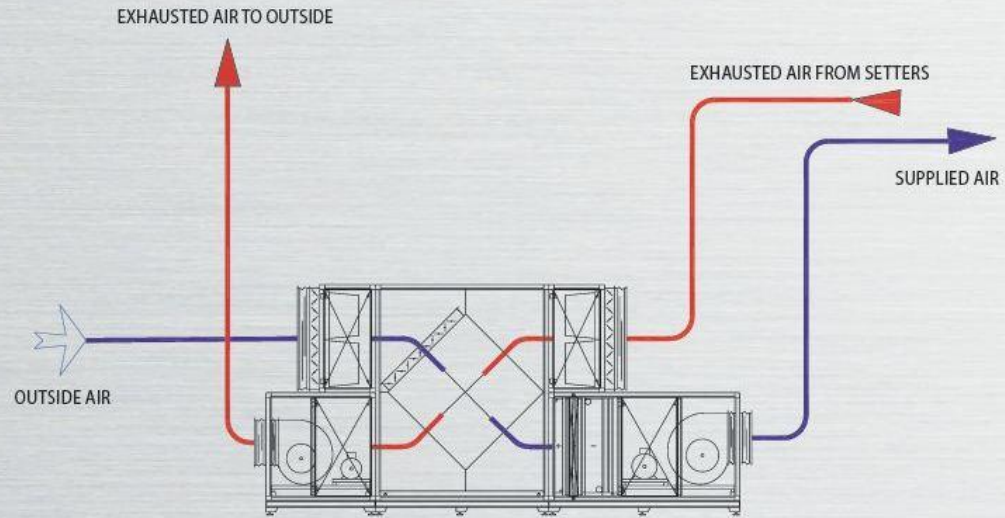

2. Rotary wheel heat exchanger

62

As the wheel rotates, heat is picked up from the exhaust air stream on the rotation.

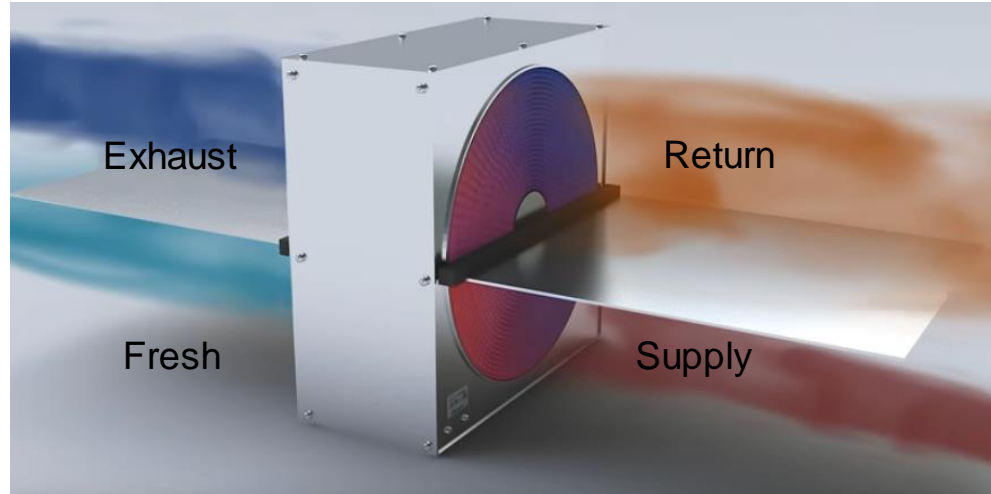

The advantage

High efficiency

The disadvantages

Direct contact between fresh air and return air



5. Cooling coils

64

1. Refrigerant Coils
2. Chilled Water Coils

Materials

1. Tubes (copper or stainless steel)
2. Fins (copper or aluminum)
3. Casing (Galvanized steel, Aluminum, or Stainless Steel)

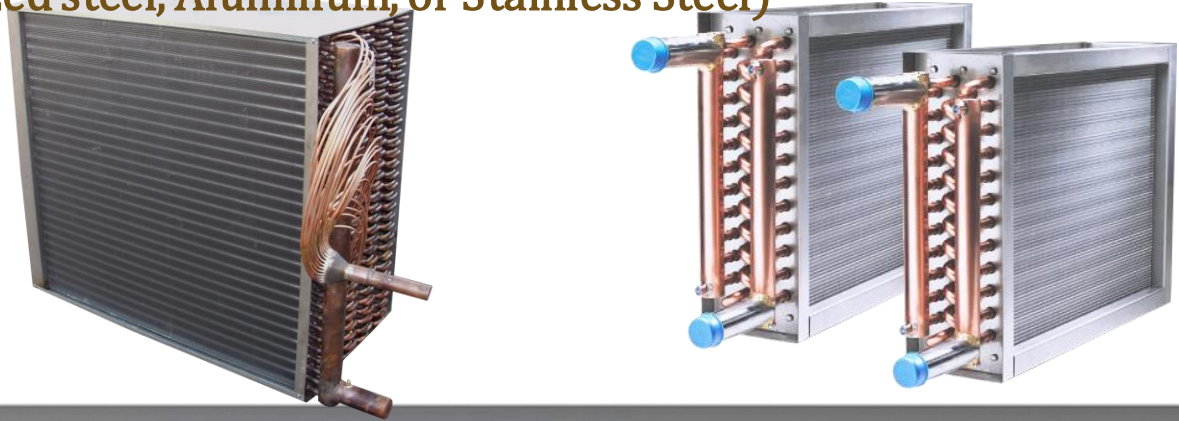

	Copper Tube & Fins	Aluminium Tube & Fins	Copper Tube & Aluminium Fins
Cost	High	Low	Mid
Efficiency	High	Mid	Mid
Resistant to Corrosion	No	Yes	No
Durability	Durable	Probably Durable	Less durable
Repair Difficulty	Easy	Extremely hard	It depends where leaks

6. Heating coils

66

1. Steam Coils
2. Hot Water

Materials

1. Steam Tubes (steel or stainless steel)
2. Hot water tubes (copper or aluminum)
3. Fins (copper or aluminum, Steel)
4. Casing (Galvanized steel, Aluminum, or Stainless Steel)

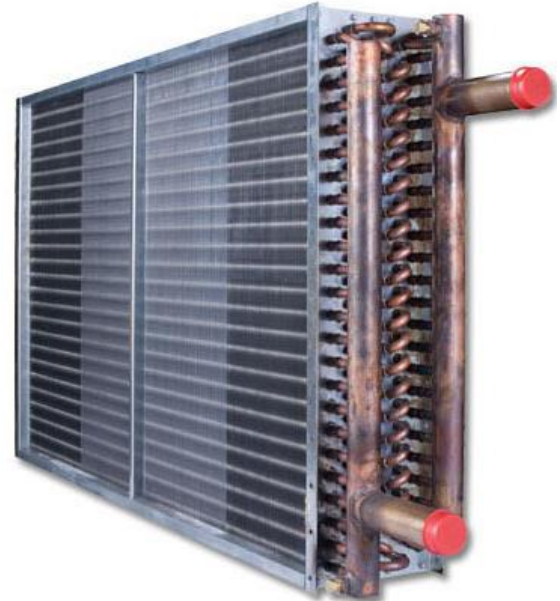

7. Supply fan

The centrifugal fan is the common usage (backward and forward)

67

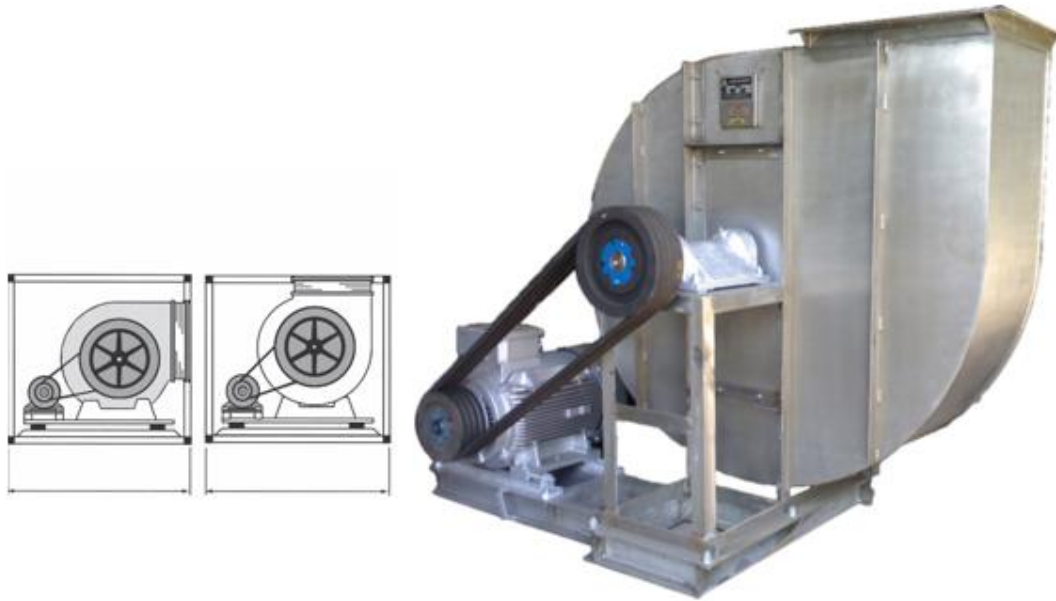

8. Humidifiers

68

1. Spray type air washer
2. Steam humidifiers
3. Wet deck humidifier



1. Spray type air washer

69

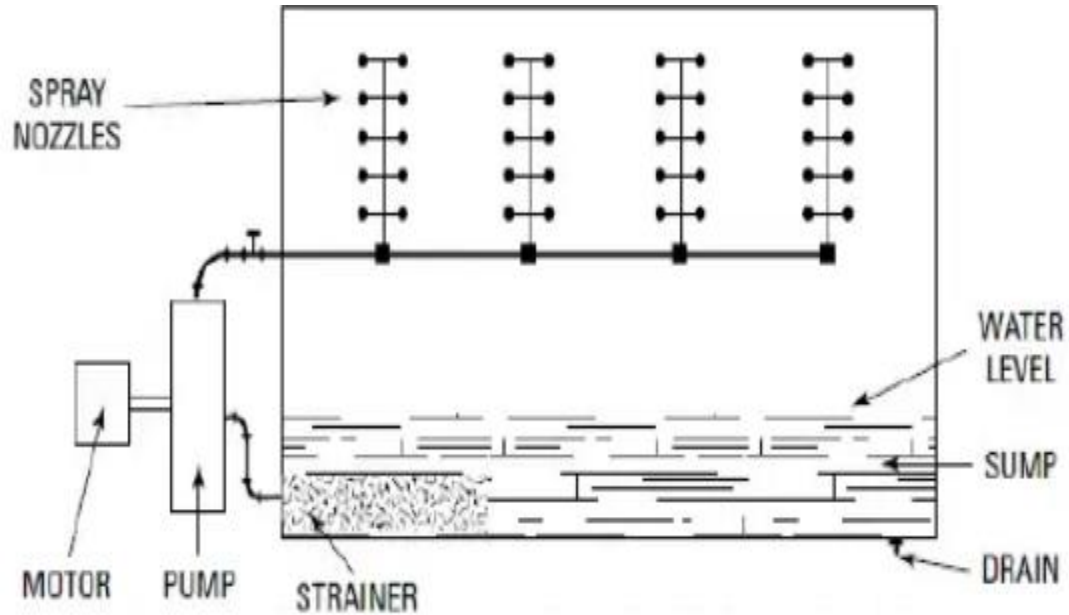

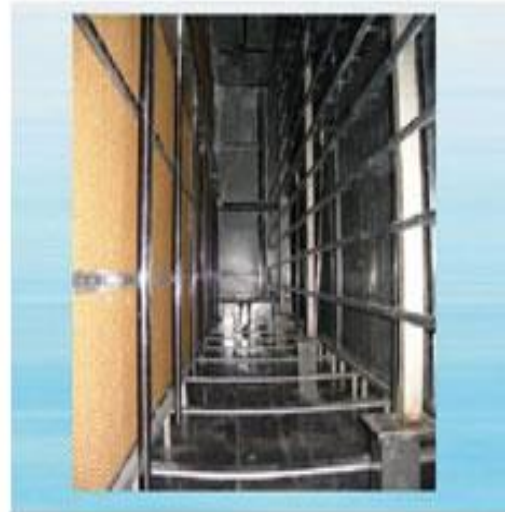

2. Steam humidifiers

71

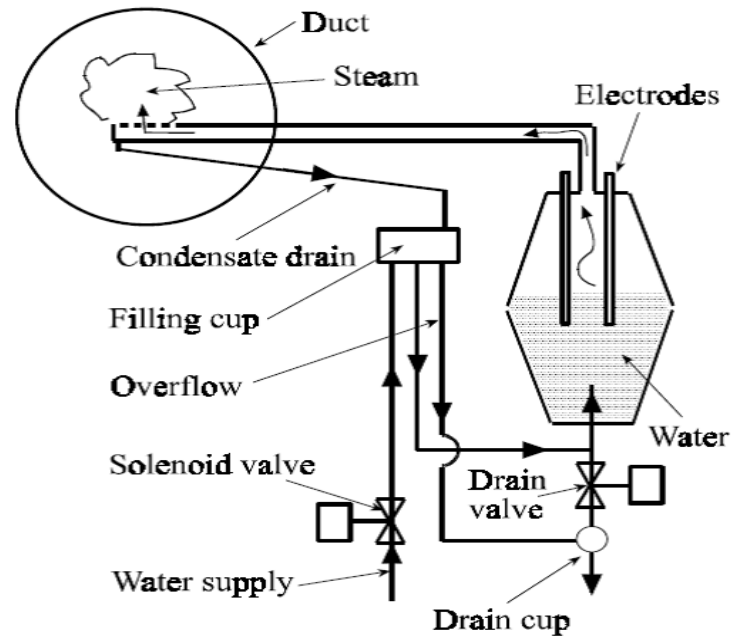

3. Wet deck humidifier

72



Wet Film Humidifier

10. Sound attenuators

73

- Some air conditioners are noisier than others, proper installation of the systems ensure they run smoothly and produce less noise.

Rectangular(splitter type)



Hygienic AHU

The main differences between AHU and Hygienic AHU :

74

1. Double Skin Panel requirements
 - I. Outer skin >>> Galvanized or Galvanized painted
 - II. Panel sandwich >>> Foam or Rockwood or Fiberglass
 - III. Inner panel >>> Stainless steel or Aluminum or Galvanized

- Inner panel should be round edges to avoid accumulation of bacteria's on corners



2. Using the Absolute filters (HEPA & EPA)

75



3. Fixing of filters

The efficiency in filtration (Air leakage factor)

ZERO INFILTRATION

4. Supply fan >>>(Plug fan)

76

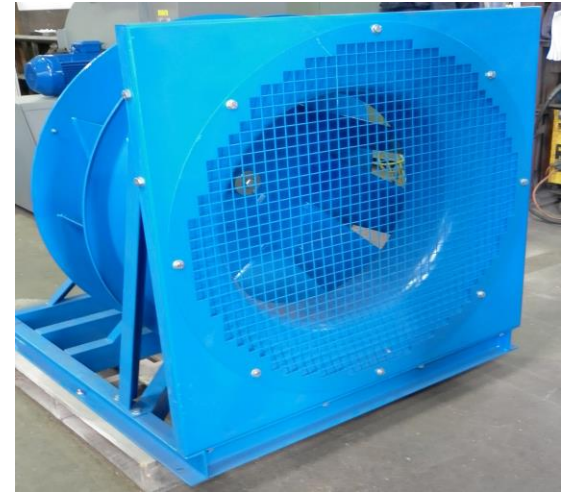
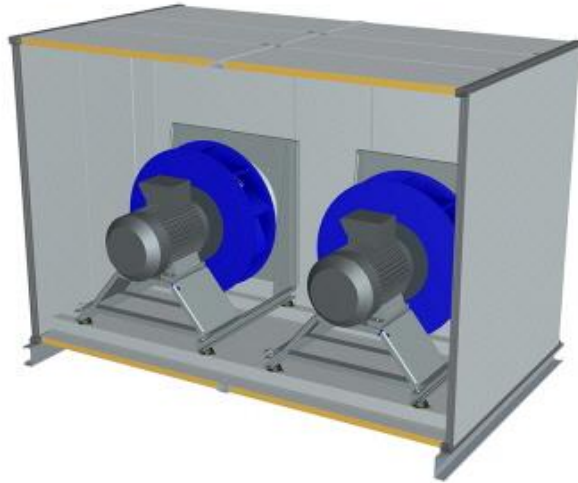

- Supply fan should be Plug fan type(without belt drive) to avoid existing of pollutants caused by belt drive or casing

Hygienic air handling units are used in :

77

- **Surgical operating rooms**
- **Clean rooms, food**
- **Medicine**
- **Chemistry facilities, Etc.**

Different Configurations AHU

Inline - Supply 100% Outdoor Air

78

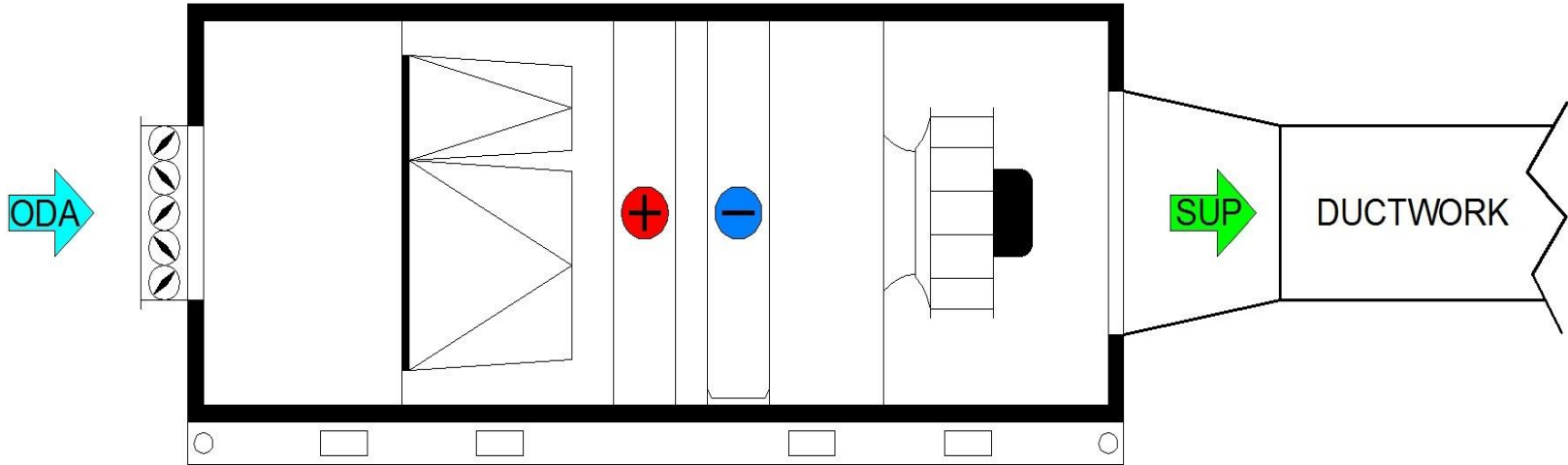

ODA - Outdoor Air
SUP - Supply Air

Note: Front View

Inline - Supply Mixed Air

79

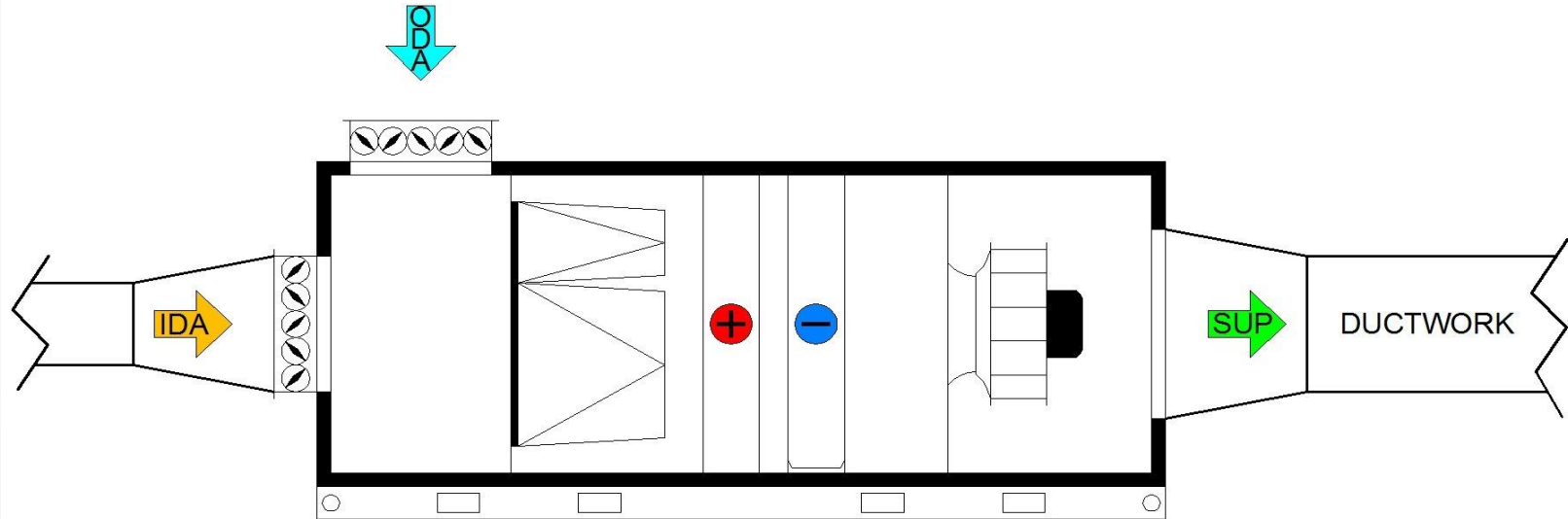

Note: Front View

ODA - Outdoor Air
SUP - Supply Air
IDA - Indoor Air

Double deck-100% Outdoor Air

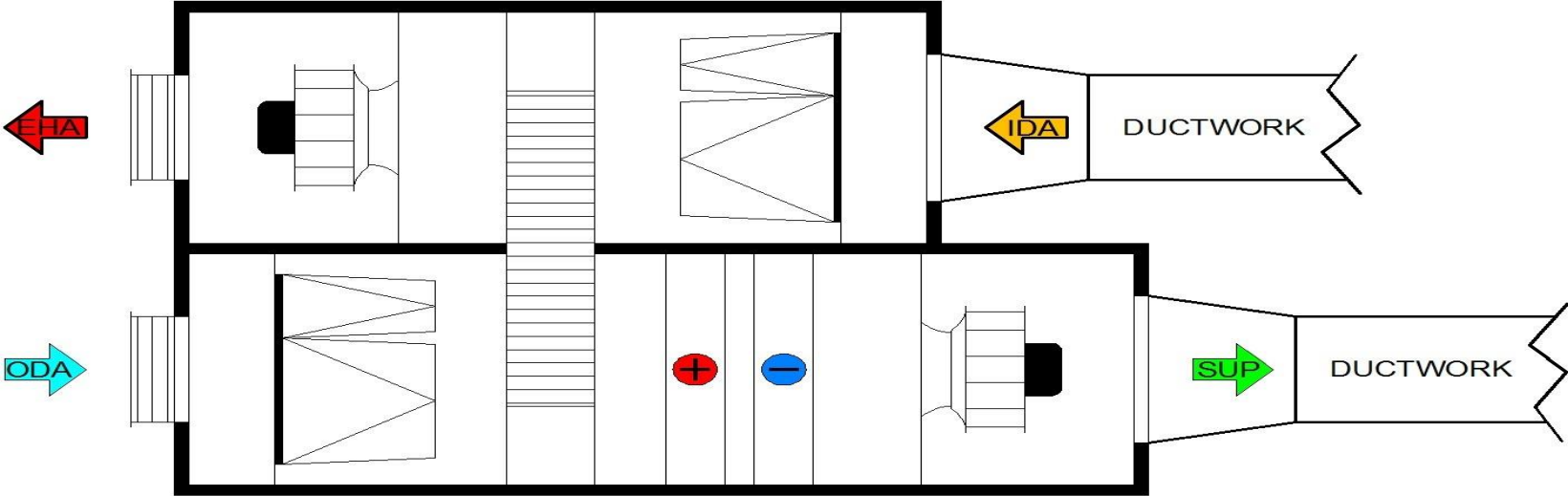

Note: Top View

- ODA - Outdoor Air
- SUP - Supply Air
- IDA - Indoor Air
- EHA - Exhaust Air

U Shape - Supply 100% Outdoor Air

81

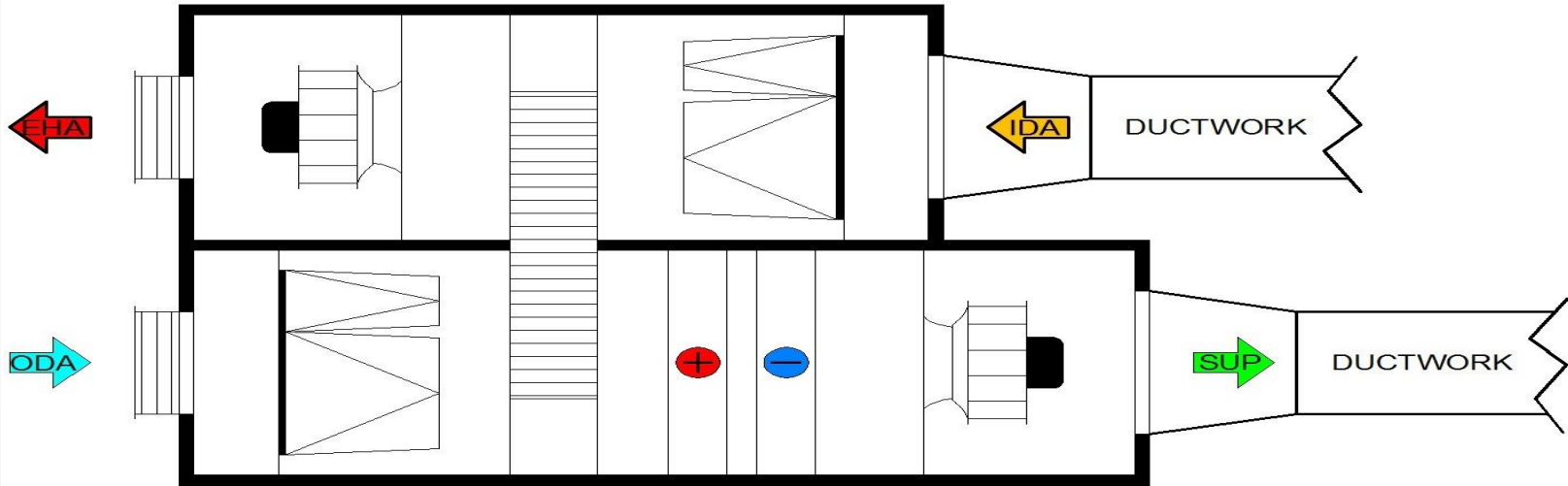

Note: Top View

ODA - Outdoor Air
SUP - Supply Air
IDA - Indoor Air
EHA - Exhaust Air

L Shape - Supply 100% Outdoor Air

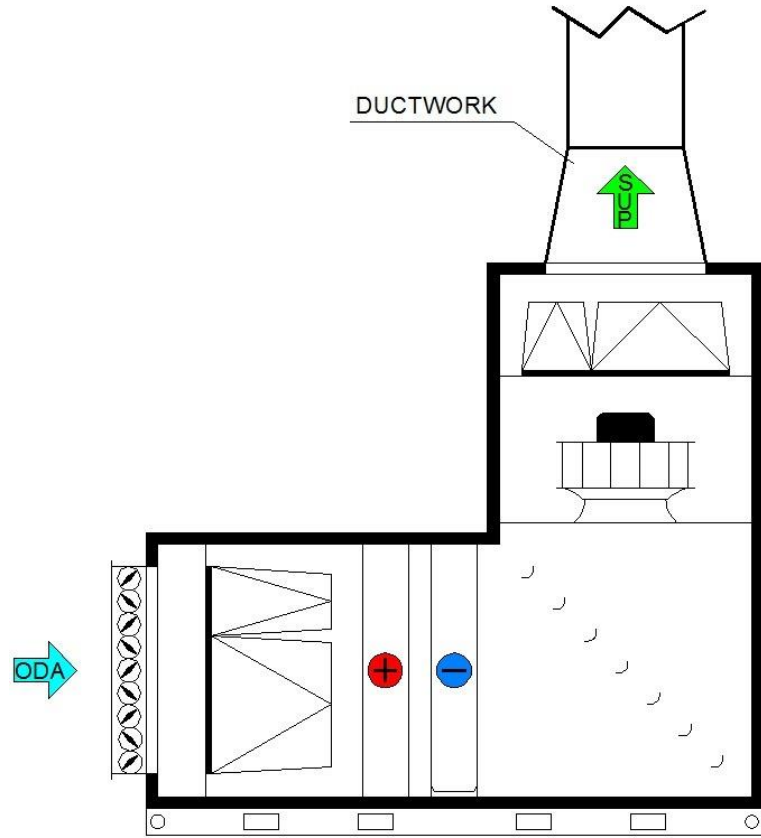

ODA - Outdoor Air
SUP - Supply Air

Note: Front View

Thanks