

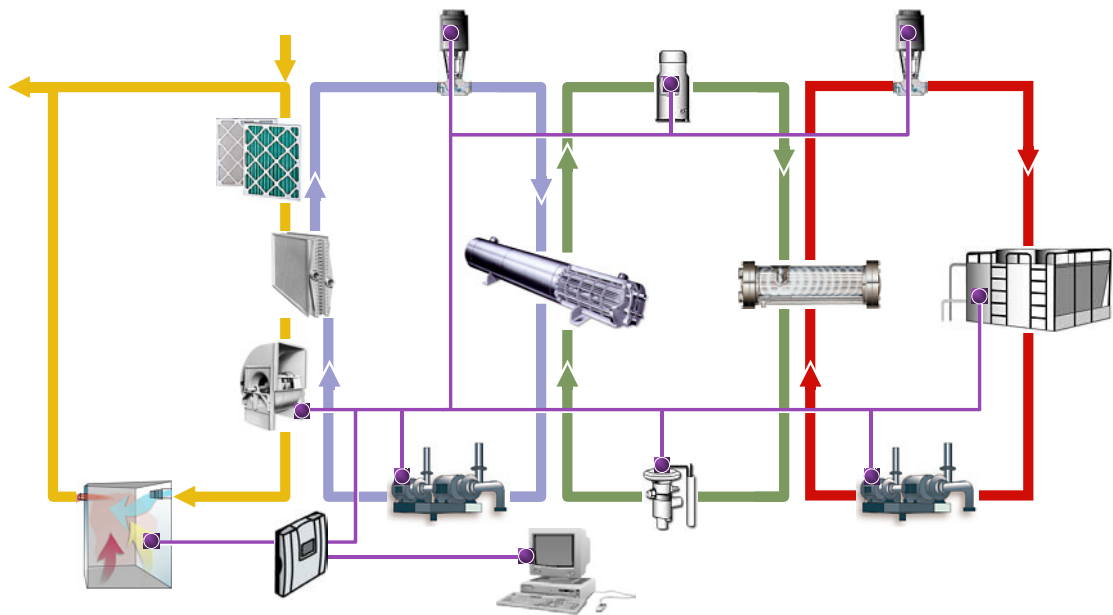

Air Conditioning Clinic

Introduction to HVAC Systems

One of the Systems Series





Introduction to HVAC Systems

One of the Systems Series

A publication of Trane

Preface

Introduction to HVAC Systems

A Trane Air Conditioning Clinic

Figure 1

Trane believes that it is incumbent on manufacturers to serve the industry by regularly disseminating information gathered through laboratory research, testing programs, and field experience.

The Trane Air Conditioning Clinic series is one means of knowledge sharing. It is intended to acquaint a technical audience with various fundamental aspects of heating, ventilating, and air conditioning (HVAC). We have taken special care to make the clinic as uncommercial and straightforward as possible.

Illustrations of Trane products only appear in cases where they help convey the message contained in the accompanying text.

This particular clinic introduces the reader to **HVAC systems**.

Trane and the Trane logo are registered trademarks of Trane.

Contents

period one	Dissecting HVAC Systems	1
	Airside Loop	3
	Chilled-Water Loop	12
	Refrigeration Loop	16
	Heat-Rejection Loop	22
	Controls Loop	27
period two	Direct-Expansion (DX) Versus Chilled-Water Systems	30
	Direct-Expansion (DX) Systems	30
	Chilled-Water Systems	34
	Factors Affecting the Decision	36
period three	Common HVAC System Types	44
	Single-Zone Systems	45
	Multiple-Zone Systems	57
period four	Factors That Affect Selection of the HVAC System	68
	Preference of Building Owner	68
	Available Construction Budget	69
	Size and Shape of Building	70
	Function of Building	71
	Architectural Limitations	72
	Life-Cycle Cost	73
	Ease of Operation and Maintenance	74
	Time Available for Construction	75
period five	Review	76
	Quiz	82
	Answers	84
	Glossary	85



period one

Dissecting HVAC Systems

notes

Introduction to HVAC Systems

period one

Dissecting HVAC Systems

Figure 2

The goal of the heating, ventilating, and air conditioning (HVAC) system is to create and maintain a comfortable environment within a building.

Comfort Requirements

- Temperature
- Humidity
- Air movement
- Fresh air
- Clean air
- Noise levels
- Lighting
- Furniture and work surfaces



Figure 3

A comfortable environment, however, is broader than just temperature and humidity. Comfort requirements that are typically impacted by the HVAC system include:

- Dry-bulb temperature
- Humidity
- Air movement
- Fresh air
- Cleanliness of the air
- Noise levels

period one

Dissecting HVAC Systems

notes

Some HVAC systems address these comfort requirements better than others. In addition, there are other factors that affect comfort but are not directly related to the HVAC system. Examples include adequate lighting, and proper furniture and work surfaces.

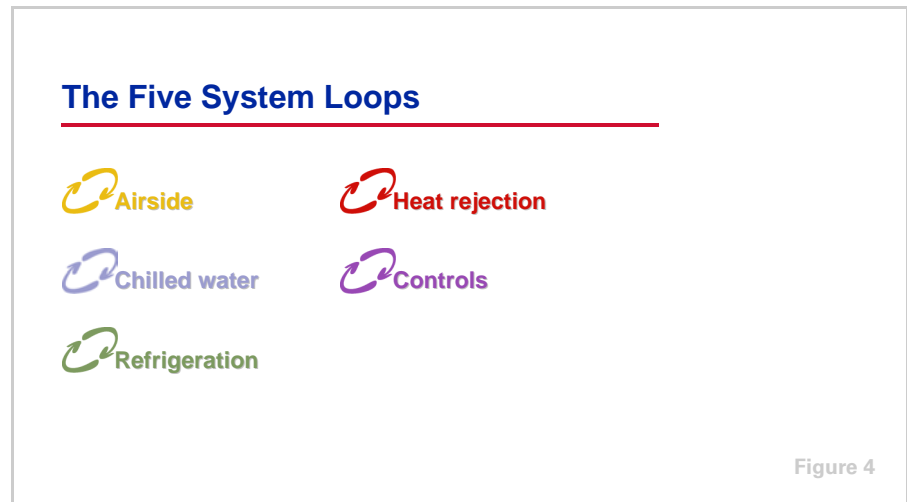

The purpose of this period is to provide a method for understanding the components of different types of HVAC systems. The premise of this method is that any HVAC system can be dissected into basic subsystems. These subsystems will be referred to as “loops.” There are five primary loops that can describe virtually any type of HVAC system.

- Airside loop (yellow)
- Chilled-water loop (blue)
- Refrigeration loop (green)
- Heat-rejection loop (red)
- Controls loop (purple)

Before we continue, keep in mind these three observations. First, while these five loops can be used to describe virtually any HVAC system, not every system uses all five loops.

Second, the temperatures used in this period are representative of conditions found in a typical HVAC system, but will differ from application to application.

And third, while another loop could be added for heating and humidifying the space in some systems, this clinic focuses primarily on comfort cooling, not heating.

period one
Dissecting HVAC Systems

notes

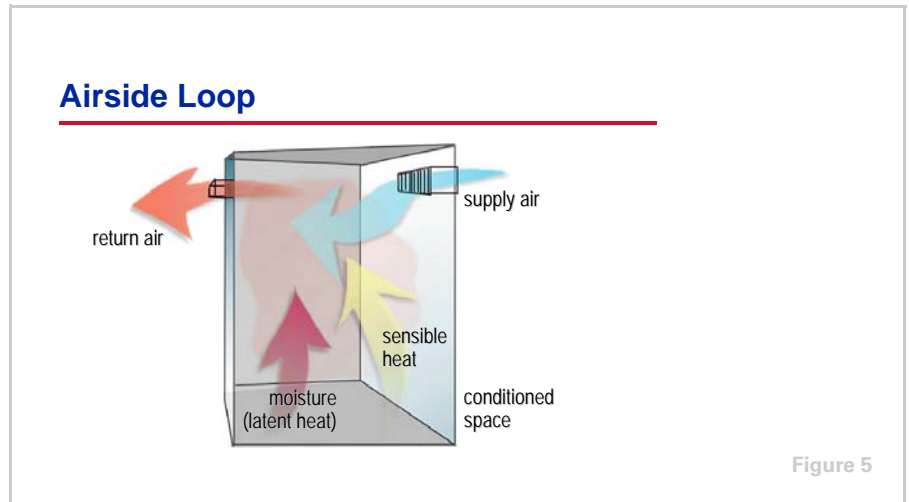

Airside Loop

The first loop is the airside loop, and the first component of this loop is the **conditioned space**. The first two comfort requirements mentioned were dry-bulb temperature and humidity. In order to maintain the dry-bulb temperature in the conditioned space, heat (referred to as sensible heat) must be added or removed at the same rate as it leaves or enters the space. In order to maintain the humidity level in the space, moisture (sometimes referred to as latent heat) must be added or removed at the same rate as it leaves or enters the space.

Most HVAC systems used today deliver conditioned (heated, cooled, humidified, or dehumidified) air to the conditioned space to add or remove sensible heat and moisture. This conditioned air is called supply air. The air that carries the heat and moisture out of the space is called return air.

Imagine the conditioned supply air as a sponge. In the cooling mode, as it enters a space, this "sponge" (supply air) absorbs sensible heat and moisture. The amount of sensible heat and moisture absorbed depends on the temperature and humidity, as well as the quantity, of the supply air. Assuming a fixed quantity of air, if the supply air is colder, it can remove more sensible heat from the space. If the supply air is drier, it can remove more moisture from the space.

period one

Dissecting HVAC Systems

notes

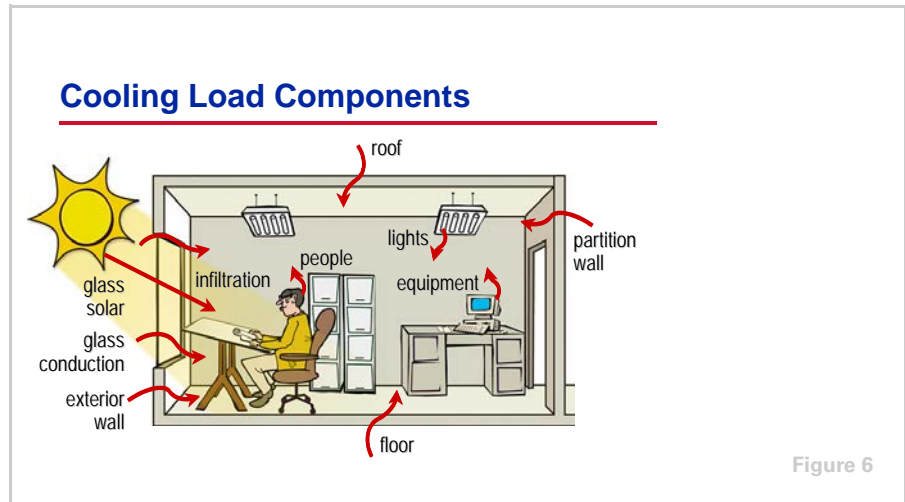

In order to determine how much supply air is needed for a given space, and how cold and dry it must be, it is necessary to determine the rate at which sensible heat and moisture (latent heat) enter, or are generated within, the conditioned space.

Figure 6 shows typical sources of heat and moisture, which are commonly called cooling loads:

- Conduction heat gain from outdoors through the roof, exterior walls, and glass windows or skylights.
- Solar radiation heat gain through glass windows or skylights.
- Conduction heat gain through the ceiling, interior partition walls, and the floor.
- Internal heat and moisture generated by people, lights, appliances, and equipment in the space.
- Heat gain from air infiltrating into the space from outdoors.

In addition to those depicted on Figure 6, other common sources of heat and moisture include:

- Heat gain from outdoor air deliberately brought into the building for ventilation purposes.
- Heat generated by the fans and motors in the system.

For further information on the various components of building cooling and heating loads, see the *Cooling and Heating Load Estimation* Air Conditioning Clinic (literature order number TRG-TRC002-EN).

period one

Dissecting HVAC Systems

notes

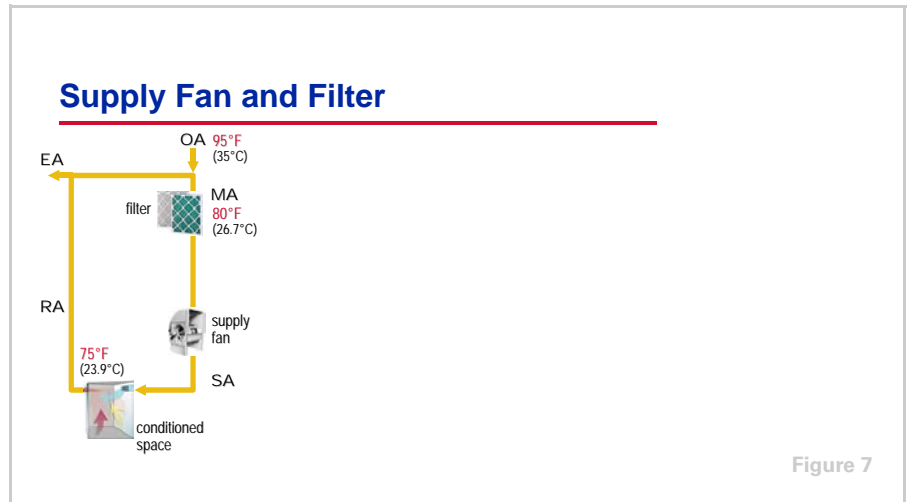

The next component of the airside loop is a **supply fan** that delivers the supply air (SA) to the space. In the example in Figure 7, air is supplied to the conditioned space to maintain a desired temperature of 75°F (23.9°C) in the space.

This same supply fan is often used to also draw the return air out of the space. Alternatively, some systems use a second fan, called a return fan, to draw air from the space and move it back to the equipment that contains the supply fan.

Another one of the comfort requirements is to provide an adequate amount of fresh, outdoor air to the space. In this example, the required amount of outdoor air (OA) for ventilation is brought into the building and mixed with the recirculated portion of the return air (RA). The remaining return air, that which has been replaced by outdoor air, is exhausted as exhaust air (EA) from the building, often by an exhaust (or relief) fan. In this example, outdoor air at 95°F (35°C) dry bulb mixes with recirculated return air at 75°F (23.9°C) dry bulb. This mixture contains 25 percent outdoor air and 75 percent recirculated return air, so the resulting temperature of the mixed air (MA) is 80°F (26.7°C) dry bulb.

Another comfort requirement is to ensure that the air in the conditioned space is clean. Bringing in an adequate amount of fresh outdoor air, and exhausting some of the air from the space, can help meet this requirement. However, the air must also be filtered. In a typical HVAC system, the mixed air passes through a **filter** to remove many of the airborne contaminants.

period one

Dissecting HVAC Systems

notes

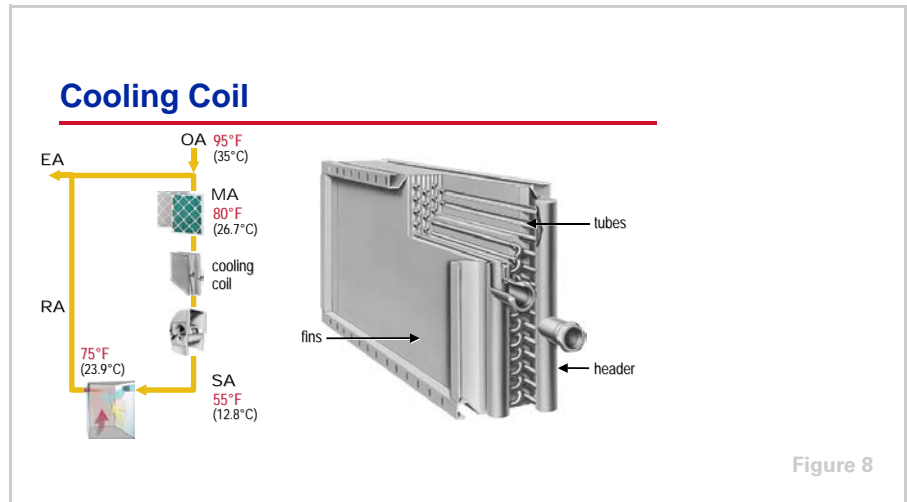

As mentioned earlier, during the cooling mode, the supply air must be cold enough to absorb excess sensible heat from the space and dry enough to absorb excess moisture (latent heat). A heat exchanger, commonly known as a **cooling coil**, is often used to cool and dehumidify the supply air before it is delivered to the space.

In this example (Figure 8), the cooling coil cools and dehumidifies the entering mixed air from 80°F (26.7°C) dry bulb to a supply-air temperature of 55°F (12.8°C) dry bulb.

A typical cooling coil includes rows of tubes passing through sheets of formed fins. A cold fluid, either water or liquid refrigerant, enters one header at the end of the coil and then flows through the tubes, cooling both the tubes and the fins.

period one

Dissecting HVAC Systems

notes

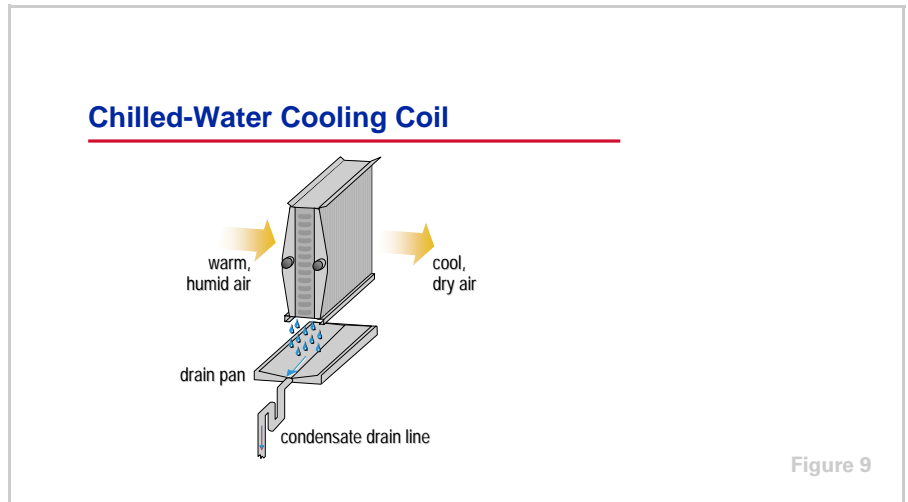

Figure 9 shows an example of a cooling coil that has chilled water flowing through it. As the warm, humid mixed air passes through the coil, it comes into contact with the cold tubes and fins. Sensible heat is transferred from the air to the fluid inside the tubes, causing the air to be cooled.

Additionally, if the outside surface temperature of the tubes and fins is below the dew-point temperature of the entering air, moisture contained in the air will condense on the tubes and fins. This condensed liquid then flows down the fin surfaces into a drain pan located underneath the coil, and is piped away. The air (supply air) leaving the coil is colder and drier than when it entered.

Many HVAC systems also use the airside loop for heating and humidification. Often, a heating coil or humidifier is located near the cooling coil in the same airside loop. Alternatively, a heating coil or humidifier may be part of a second, separate airside loop. Assuming a fixed quantity of air, if the supply air is warmer, it can add more sensible heat to the space. If the supply air is more humid, it can add more moisture to the space. For simplicity, however, this period focuses primarily on comfort cooling.

period one

Dissecting HVAC Systems

notes

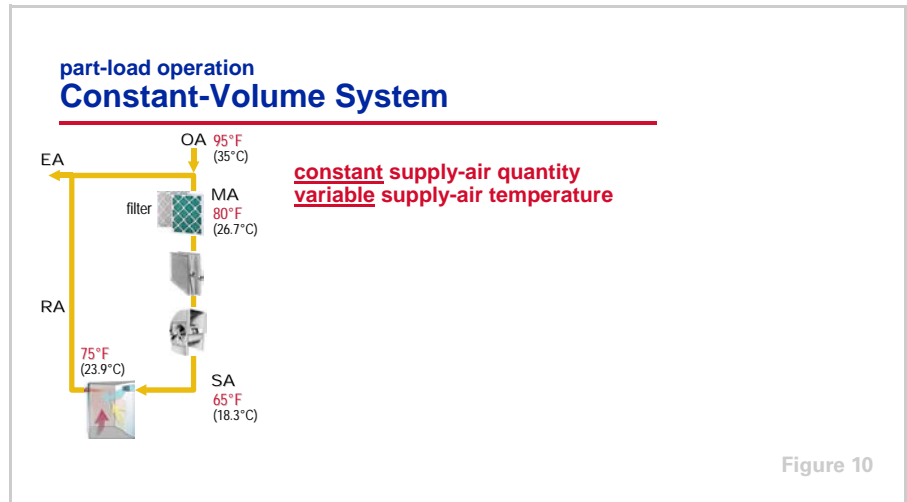

Finally, the supply air is delivered to the conditioned space. The temperature and humidity of the supply air, however, are only applicable for one point in time. The cooling requirement (load) in the conditioned space varies throughout the day and throughout the year. The airside loop responds to changing cooling loads in the conditioned space by varying either the temperature or the quantity of air delivered to the space.

A **constant-volume system** provides a constant quantity of supply air and varies the supply-air temperature in response to the changing cooling load in the space. A thermostat compares the dry-bulb temperature in the conditioned space to a setpoint. It then modulates cooling capacity until the space temperature matches the setpoint.

period one
Dissecting HVAC Systems

notes

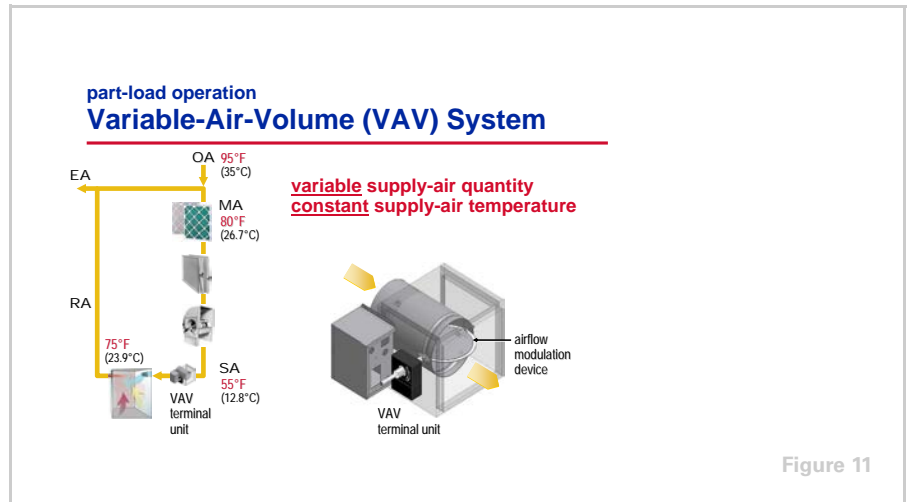

A **variable-air-volume (VAV) system** varies the quantity of constant-temperature supply air in response to the changing cooling load in the space.

In this system, a VAV terminal unit is added to the airside loop. Each conditioned space, or group of similar spaces (called a zone), has a separate VAV terminal unit that varies the quantity of supply air delivered to that space or zone. The VAV terminal unit contains an airflow modulation device, typically a rotating-blade damper.

A thermostat compares the dry-bulb temperature in the conditioned space to a setpoint. It then modulates the quantity of supply air delivered to the space by changing the position of the airflow modulation device in the VAV terminal unit. The capacity of the supply fan is modulated to deliver only the quantity of supply air needed, and cooling capacity is modulated to maintain a constant supply-air temperature.

period one
Dissecting HVAC Systems

notes

Fan-Coil Unit

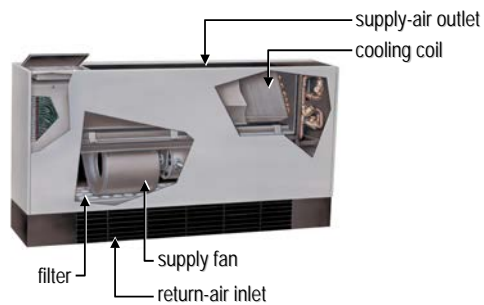

Figure 12

A simple example of the airside loop is a fan-coil unit. Figure 12 is an example of a fan-coil unit that would be installed in the conditioned space. Return air from the space is drawn into the unit at the base and can be mixed with outdoor air that enters through a separate damper in the back of the unit. This mixed air passes through a filter, a supply fan, and a cooling coil before being discharged from the top of the unit, directly into the conditioned space.

Central Air Handler

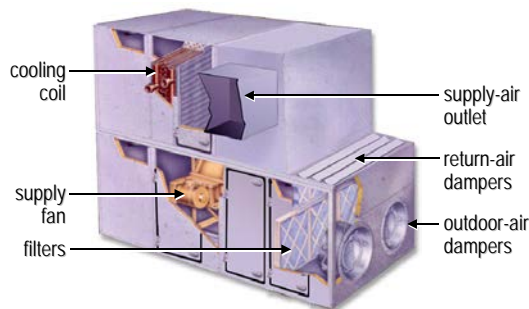

Figure 13

Another example of the airside loop is a central air-handling system. A central air handler is typically installed outside of the conditioned space, possibly on the roof or in a dedicated mechanical room. Figure 13 depicts a simple example of a central indoor-air handler.

Return air from the space is drawn into the unit through the return-air dampers and mixes with outdoor air that enters through another set of dampers. This

period one

Dissecting HVAC Systems

notes

mixed air passes through the filters, the supply fan, and the cooling coil before being discharged from the air handler.

Unlike the example fan-coil unit that was installed in the conditioned space, the central air handler needs a method for delivering the supply air to the conditioned space(s).

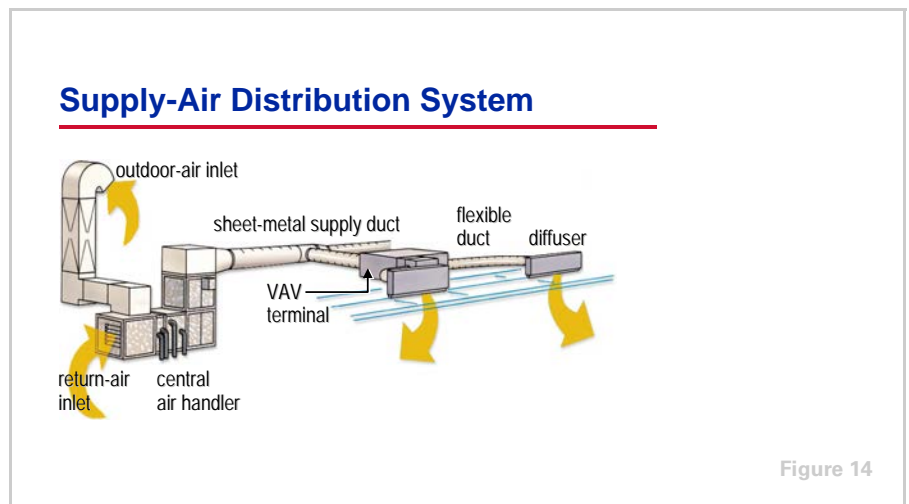

A supply-air distribution system, typically constructed of sheet-metal ducts, fittings, and diffusers, is used to direct the supply air from the central air handler to one or more conditioned spaces. The example airside loop in Figure 14 includes a central air handler and ductwork to deliver supply air to multiple VAV terminal units.

From each VAV terminal unit, the supply air travels through a section of flexible duct to remotely located diffusers. **Diffusers** are used to distribute the supply air effectively to the conditioned space. Proper air diffusion is an important comfort consideration, especially in VAV systems, to avoid dumping cold supply air on the occupants of the space.

period one

Dissecting HVAC Systems

notes

Ceiling Plenum Return

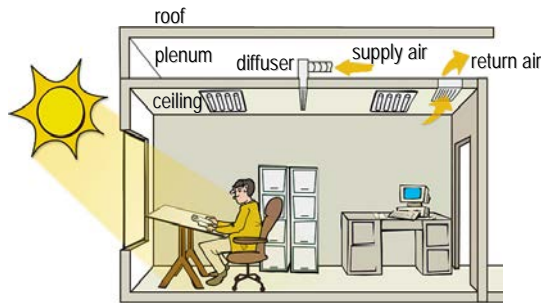

Figure 15

In Figure 15, air returns from the conditioned space to the central air handler through an open ceiling plenum. The plenum is the space between the ceiling and the roof, or floor, above.

Alternatively, a separate return-air duct system could be used to direct the return air back to the air handler.

Chilled-Water Loop

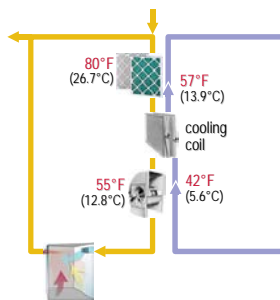

Figure 16

Chilled-Water Loop

In the airside loop, a **cooling coil** is used to cool and dehumidify the supply air. As mentioned, the cold fluid flowing through the tubes of the coil may be either water or liquid refrigerant. Systems that use water flowing through the cooling coil also contain a chilled-water loop.

Heat energy flows from a higher-temperature substance to a lower-temperature substance. Therefore, in order for heat to be transferred from the air, the fluid

period one

Dissecting HVAC Systems

notes

flowing through the tubes of the cooling coil must be colder than the air passing over the tubes and fins. In Figure 16 on page 12, chilled water at 42°F (5.6°C) flows through the coil, absorbing heat from the air. The water leaves the coil at a warmer temperature—57°F (13.9°C).

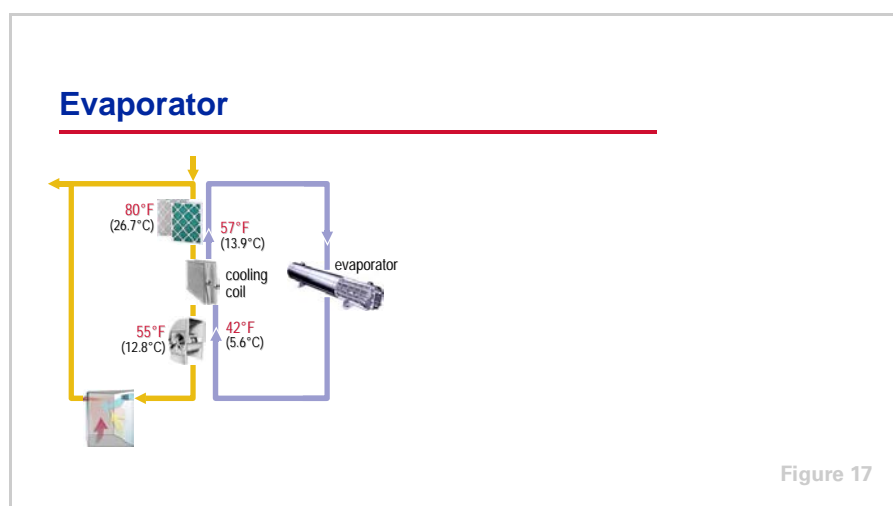

It has also been mentioned that the water flowing through the cooling coil must be colder than the air passing through it. A heat exchanger is used to cool the water that returns from the coil—at 57°F (13.9°C)—back to the desired supply-water temperature of 42°F (5.6°C). This heat exchanger, called an **evaporator**, is one component of the refrigeration (cooling) equipment.

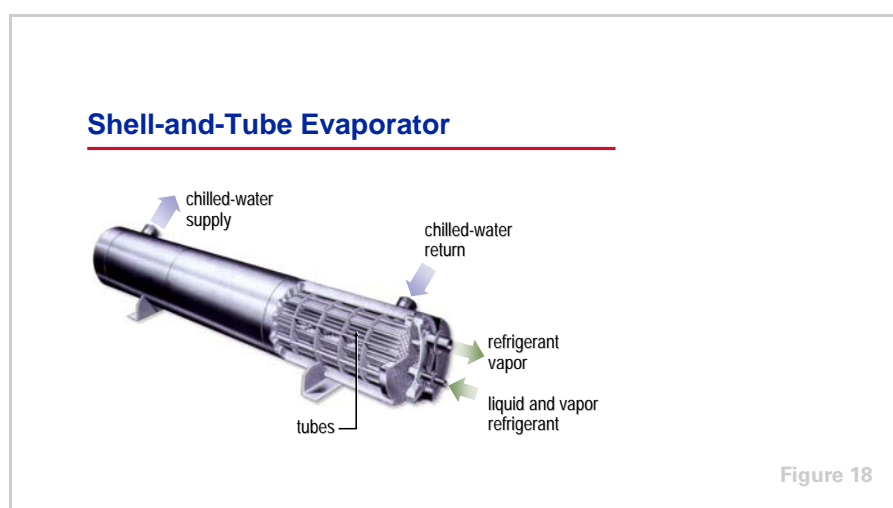

Figure 18 shows a shell-and-tube evaporator that has cold liquid refrigerant flowing through the tubes. Warm water enters at one end of the shell and fills the space surrounding the tubes. Heat is transferred from the water to the

period one

Dissecting HVAC Systems

notes

refrigerant inside the tubes, and chilled water leaves from the opposite end of the shell.

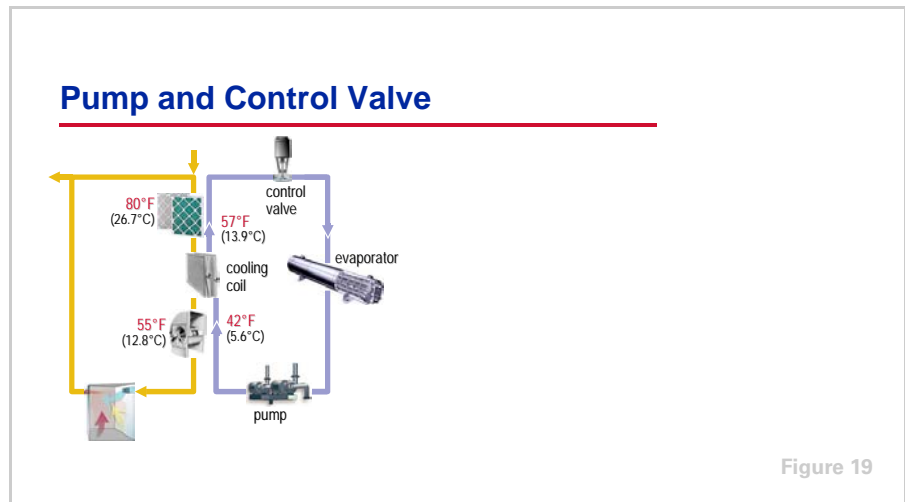

The third component of the chilled-water loop is a **pump** that moves water around the loop. This pump needs to have enough power to move the water through the piping, the evaporator, the tubes of the coil, and any other accessories installed in the chilled-water loop.

Similar to the airside loop, the chilled-water loop responds to changing cooling loads by varying either the temperature or the quantity of water delivered to the cooling coil. The most common method, however, is to vary the quantity of water flowing through the cooling coil by using a **control valve**. As the cooling load decreases, the modulating control valve reduces the rate of chilled-water flow through the coil, decreasing its cooling capacity.

period one
Dissecting HVAC Systems

notes

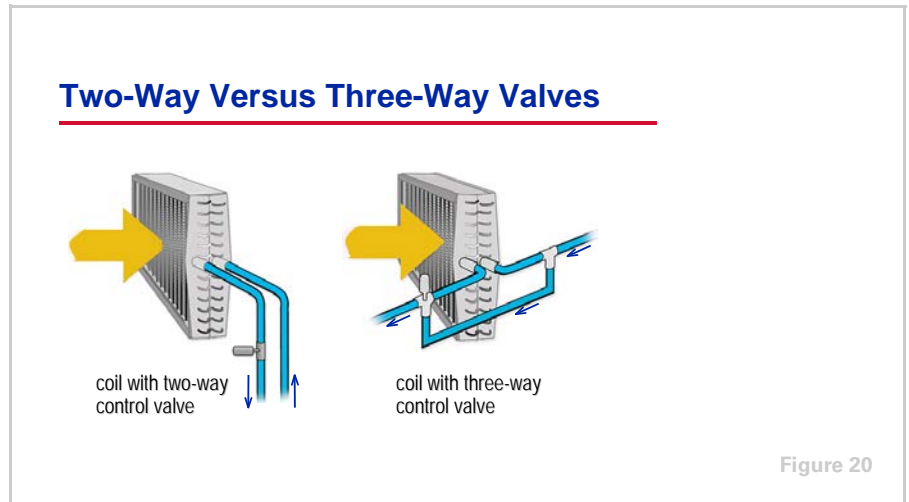

At part-load conditions, a two-way control valve reduces the rate of chilled-water flow through the coil. A three-way control valve also reduces the rate of flow through the coil, but it bypasses the excess water to mix downstream with the water that flows through the coil.

With a three-way valve, the quantity of water flowing through the system (water flowing through the coil plus water bypassing the coil) is constant at all loads. With a two-way valve, the water flowing through the system varies, which allows the pump to reduce its capacity and save energy at part load.

Notice that the control valve is located at the outlet, or downstream, of the cooling coil. This location ensures that the tubes inside the coil are always full of water. A valve located at the inlet, or upstream, of the coil may modulate to the point where the water just “trickles” through the tubes, not filling the entire tube diameter. The result is unpredictable heat transfer and less-stable control.

period one

Dissecting HVAC Systems

notes

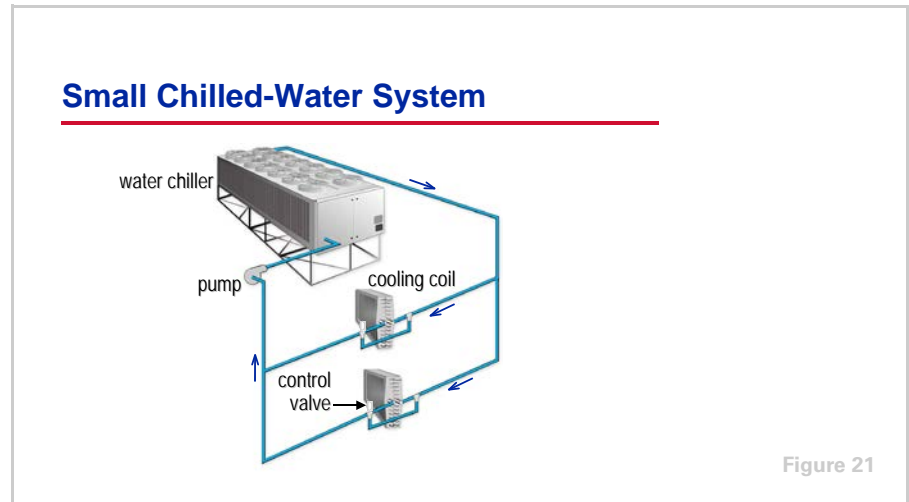

A simple example of the chilled-water loop is shown in Figure 21. A packaged water chiller produces chilled water by transferring heat from the water to the refrigerant inside the evaporator. This chilled water flows through the cooling coils, where it is used to cool and dehumidify the supply air. A pump is used to circulate water through the evaporator, the piping, the cooling coils, and the control valves. Finally, each cooling coil is equipped with a three-way control valve that varies the rate of chilled-water flow through the coil in response to changing cooling loads.

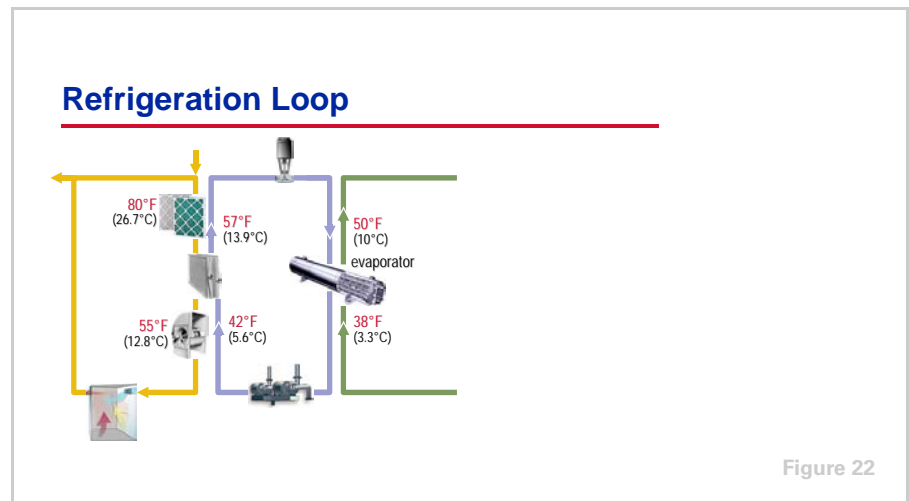

Refrigeration Loop

The third loop is the refrigeration loop. Recall that in the chilled-water loop, the **evaporator** allows heat to transfer from the water to cold liquid refrigerant. In the example in Figure 22, liquid refrigerant at 38°F (3.3°C) enters the tubes of the shell-and-tube evaporator. As heat is transferred from the water to the

period one

Dissecting HVAC Systems

notes

refrigerant, the liquid refrigerant boils. The resulting refrigerant vapor is further warmed (superheated) to 50°F (10°C) inside the evaporator before being drawn to the compressor.

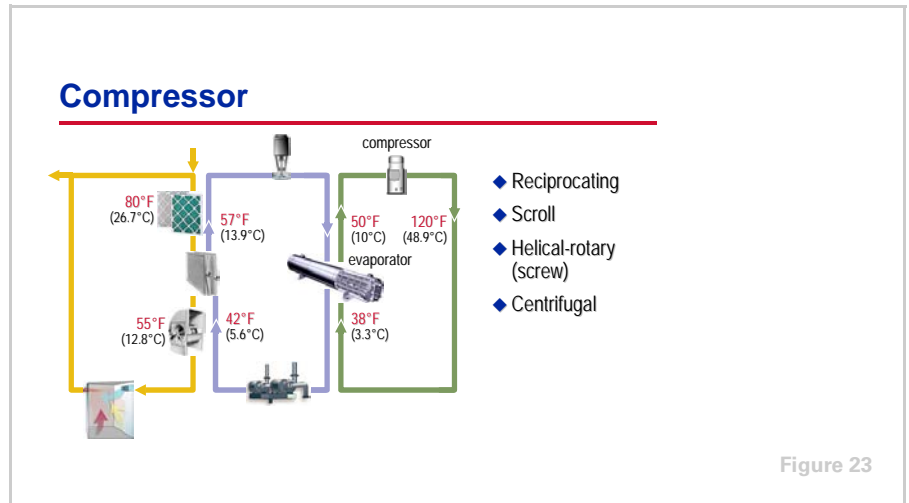

The **compressor** is used to pump the low-pressure refrigerant vapor from the evaporator and compress it to a higher pressure. This increase in pressure also raises the temperature of the refrigerant vapor—120°F (48.9°C) in Figure 23. Common types of compressors used in HVAC systems include reciprocating, scroll, helical-rotary (screw), and centrifugal.

The refrigeration loop typically responds to changing cooling loads by unloading the compressor. The method used for unloading depends on the type of compressor. Many reciprocating compressors use cylinder unloaders. Scroll compressors generally cycle on and off. Helical-rotary compressors use a slide valve or a similar unloading device. Centrifugal compressors typically use inlet vanes or a variable-speed drive in combination with inlet vanes.

period one

Dissecting HVAC Systems

notes

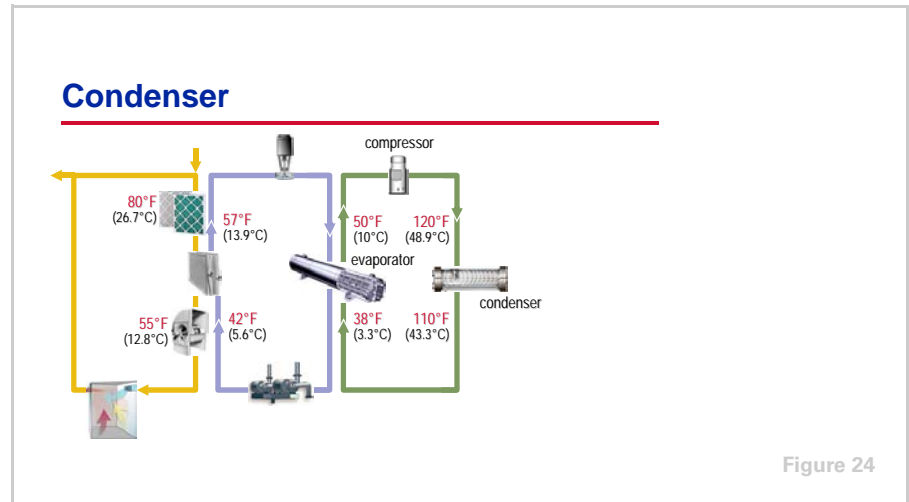

After being discharged from the compressor, the hot, high-pressure refrigerant vapor enters a **condenser**. The condenser is a heat exchanger that transfers heat from the hot refrigerant vapor to air, water, or some other fluid that is at a colder temperature. As heat is removed from the refrigerant, it condenses and returns to the liquid phase.

The condenser shown in Figure 24 is a water-cooled condenser that transfers heat from the refrigerant to a separate condenser-water loop.

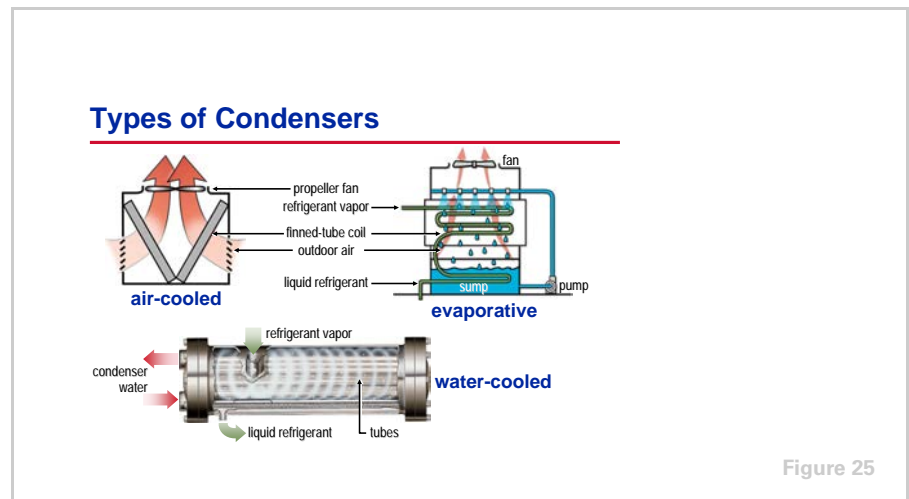

The three most common types of condensers are air-cooled, evaporative, and water-cooled. A typical **air-cooled condenser** has the hot, high-pressure refrigerant vapor flowing through the tubes of a finned-tube heat exchanger and uses propeller-type fans to draw outdoor air over the outer surfaces of the tubes and fins.

period one

Dissecting HVAC Systems

notes

A variation of the air-cooled condenser is the **evaporative condenser**. Within this device, the refrigerant flows through tubes and air is drawn or blown over the tubes by a fan. The difference is that water is sprayed on the outer surfaces of the tubes. As the air passes over the tubes, it causes a small portion of the water to evaporate. This evaporation process improves the heat transfer from the condensing refrigerant. The remaining water then falls into the sump to be recirculated by a small pump and used again.

The most common type of **water-cooled condenser** is the shell-and-tube design. With this design, water flows through the tubes while the hot refrigerant vapor fills the space surrounding the tubes. As heat is transferred from the refrigerant to the water, the refrigerant vapor condenses on the outer surfaces of the tubes and the condensed liquid refrigerant falls to the bottom of the shell.

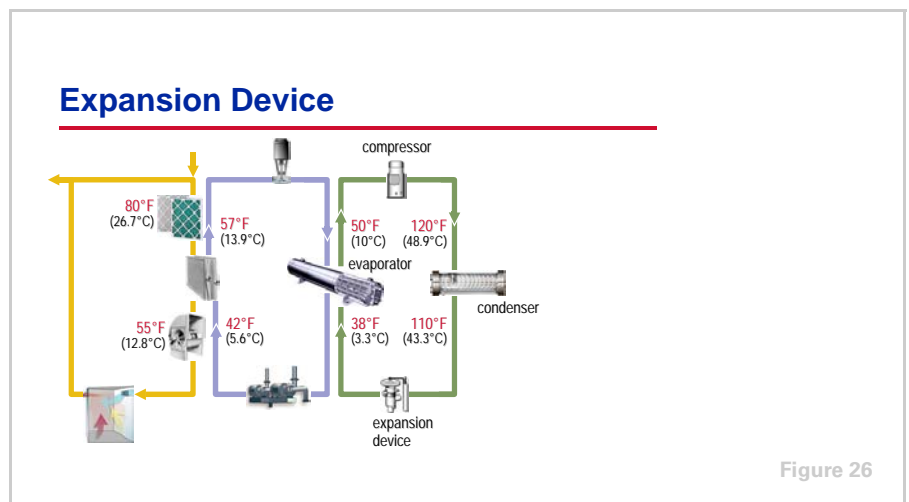

The liquid refrigerant that leaves the condenser is still at a relatively high temperature—110°F (43.3°C) in the example in Figure 26. The final step of the refrigeration cycle is for this hot liquid refrigerant to pass through an **expansion device**. This device creates a large pressure drop that reduces the pressure, and correspondingly the temperature, of the refrigerant. The temperature is reduced to a point—38°F (3.3°C) in this example—where it is again cold enough to absorb heat inside the evaporator. There are several types of expansion devices, but the one shown in this example is a thermostatic expansion valve (TXV).

For further information on the refrigeration cycle and its various components (evaporators, compressors, condensers, and expansion devices), see the *Refrigeration Cycle* (literature order number TRG-TRC003-EN), *Refrigeration Compressors* (TRG-TRC004-EN), and *Refrigeration System Components* (TRG-TRC005-EN) Air Conditioning Clinics.

period one

Dissecting HVAC Systems

notes

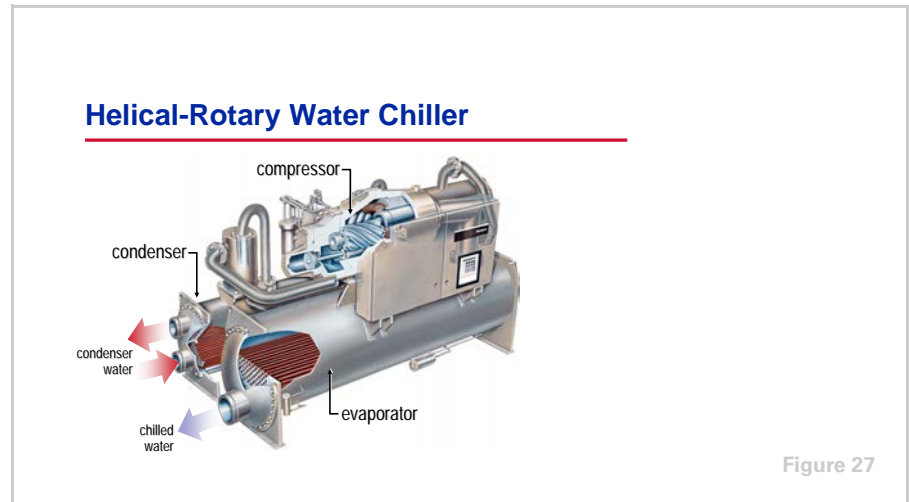

An example (Figure 27) of the refrigeration loop is a packaged, helical-rotary (screw) water chiller. This example chiller uses an evaporator to produce chilled water by transferring heat from the water to the liquid refrigerant. The compressor consists of two screw-like rotors to compress the refrigerant vapor, raising its pressure and temperature. A second heat exchanger serves as the water-cooled condenser, where refrigerant is condensed inside the shell and water flows through the tubes. The expansion device (not shown) used in this chiller is an electronic expansion valve.

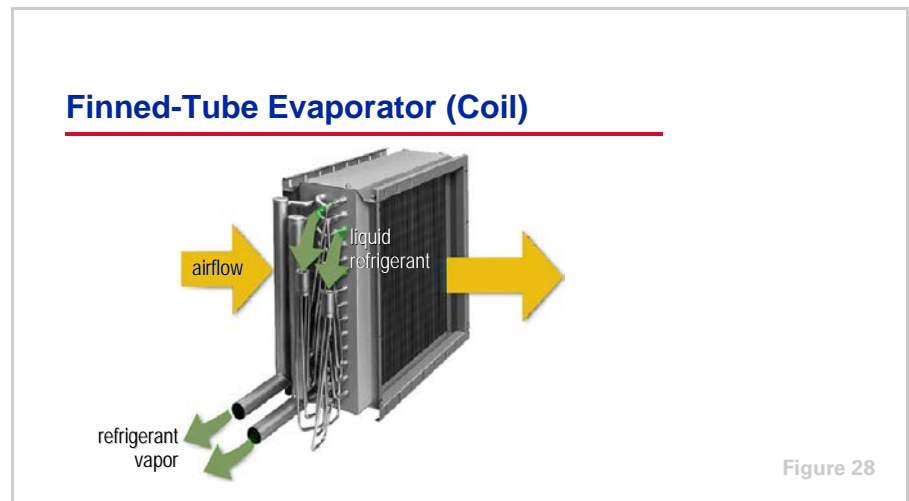

As we mentioned at the beginning of this period, not all HVAC systems use all five loops. So far, we have looked at the airside loop, the chilled-water loop, and the refrigeration loop. Instead of chilled water flowing through the tubes of the cooling coil, some systems have cold liquid refrigerant flowing through the tubes. In this case, the finned-tube cooling coil is also the evaporator of the

period one

Dissecting HVAC Systems

notes

refrigeration loop. As air passes through the coil, heat is transferred from the air to the refrigerant. This heat transfer causes the refrigerant to boil and leave the evaporator as vapor.

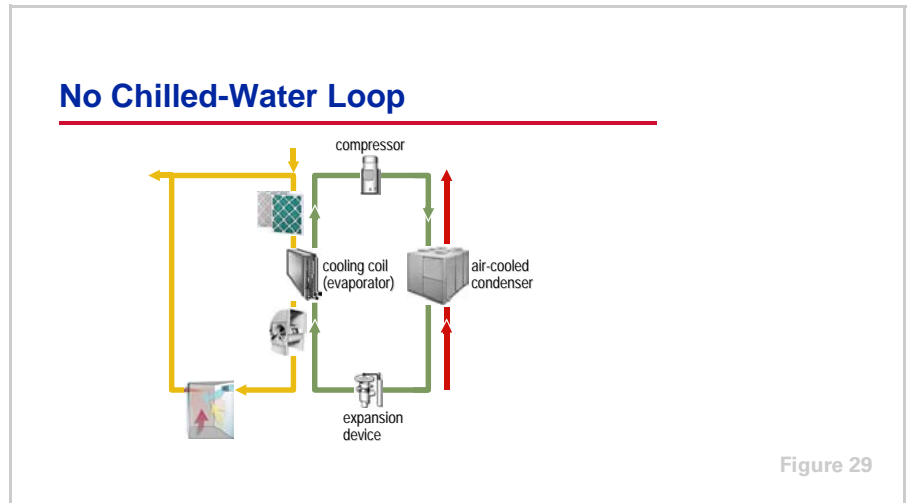

In this arrangement, the chilled-water loop does not exist. Heat is transferred from the airside loop directly to the refrigeration loop.

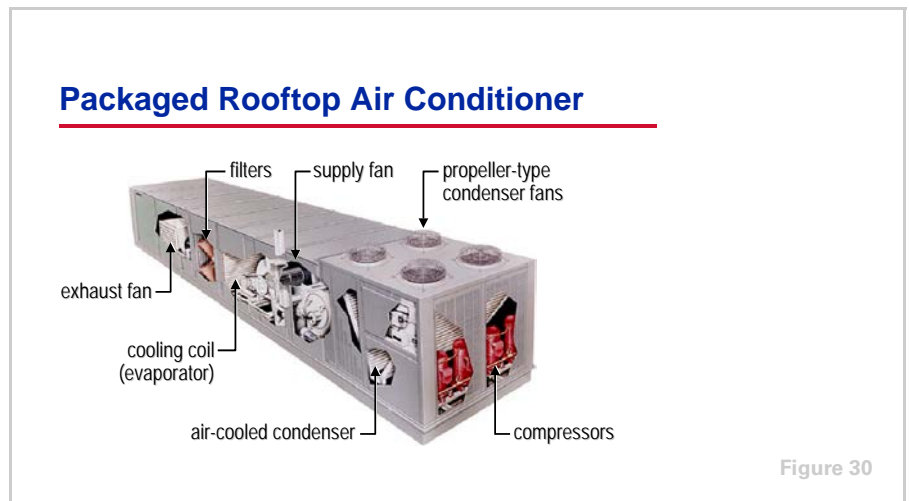

An example of a system that does not use the chilled-water loop is one that uses a packaged rooftop air conditioner, shown in Figure 30. It combines several components of the airside loop with all the components of the refrigeration loop.

Similar to the central air handler shown earlier, return air from the space is drawn into the unit and is mixed with outdoor air that enters through a separate damper. This mixed air passes through the filters, the cooling coil (which is also

period one

Dissecting HVAC Systems

notes

the evaporator), and the supply fan before it is discharged from the unit. Packaged inside this same piece of equipment are one or more compressors, an air-cooled condenser complete with propeller-type fans, and expansion devices.

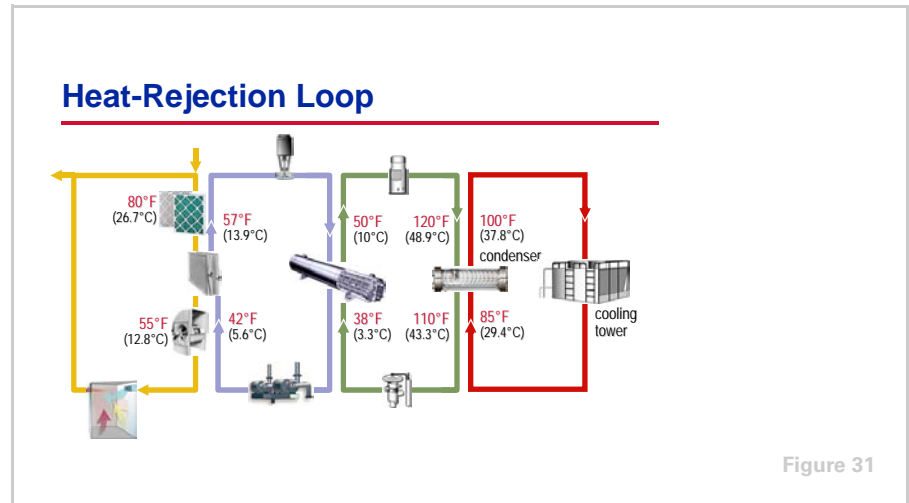

Figure 31

Heat-Rejection Loop

The fourth loop is the heat-rejection loop. In the refrigeration loop, the **condenser** transfers heat from the hot refrigerant to air, water, or some other fluid. In a water-cooled condenser, water flows through the tubes while the hot refrigerant vapor enters the shell space surrounding the tubes. Heat is transferred from the refrigerant to the water, warming the water. In Figure 31, water enters the condenser at 85°F (29.4°C), absorbs heat from the hot refrigerant, and leaves at 100°F (37.8°C).

The water flowing through the condenser must be colder than the hot refrigerant vapor. A heat exchanger is required to cool the water that returns from the condenser—at 100°F (37.8°C)—back to the desired temperature of 85°F (29.4°C) before it is pumped back to the condenser. When a water-cooled condenser is used, this heat exchanger is typically either a cooling tower or a fluid cooler (also known as a dry cooler).

period one
Dissecting HVAC Systems

notes

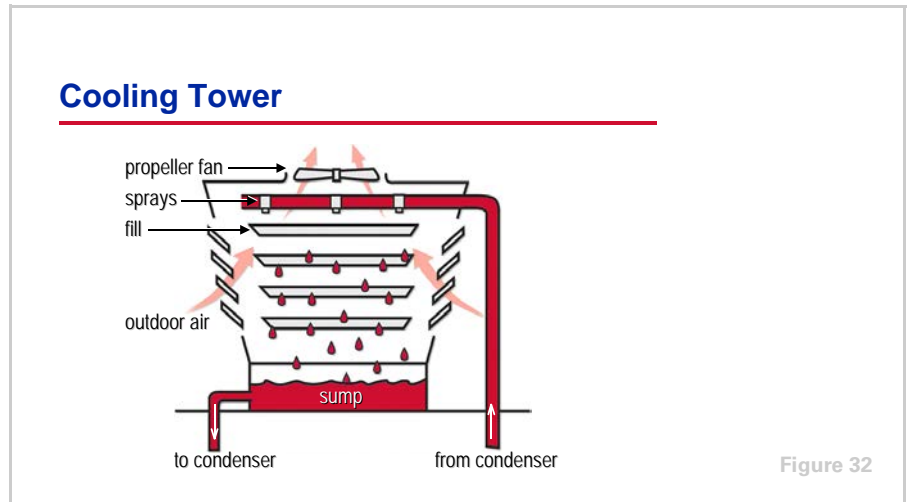

In a **cooling tower**, the warm water returning from the condenser is sprayed over the fill inside the tower while a propeller fan draws outdoor air upward through the fill. One common type of fill consists of several thin, closely spaced layers of plastic or wood. The water spreads over the surface of the fill to increase the contact with the passing air. The movement of air through the fill allows heat to transfer from the water to the air. This causes some of the water to evaporate, a process that cools the remaining water. The remaining cooled water then falls to the tower sump and is returned to the condenser.

A fluid cooler is similar to an air-cooled condenser. Water flows through the tubes of a finned-tube heat exchanger and fans draw outdoor air over the surfaces of the tubes and fins. Heat is transferred from the warmer water to the cooler air.

period one
Dissecting HVAC Systems

notes

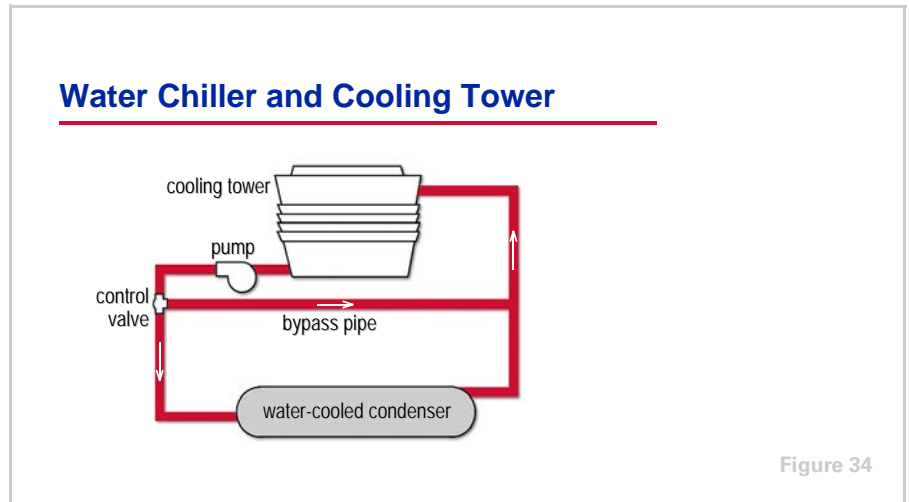

An example of the heat-rejection loop is a cooling tower along with a water-cooled chiller. Refer to Figure 34. The water-cooled condenser on this chiller transfers heat from the refrigerant to the water in the loop. This water passes through a cooling tower and heat is rejected to outdoor air passing through the tower. A pump is used to circulate water through the condenser, the piping, the cooling tower, and the control valve.

Finally, a modulating, three-way control valve is used to vary the water flow through the condenser in response to a changing heat-rejection requirement. This valve modulates the water flow through the condenser by diverting some of the water around the condenser through the bypass pipe, directly back to the cooling tower.

period one
Dissecting HVAC Systems

notes

Packaged Air-Cooled Chiller

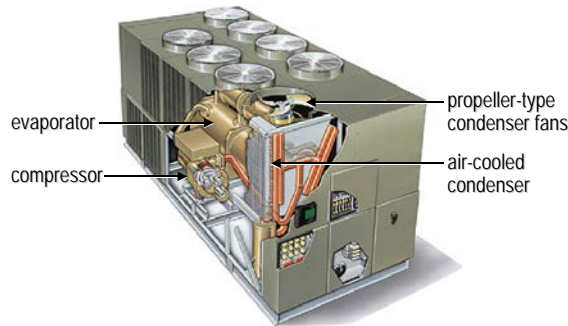

Figure 35

A second example (Figure 35) of the heat-rejection loop is a packaged, air-cooled chiller. It combines all the components of the refrigeration and heat-rejection loops.

This example air-cooled chiller contains an evaporator, two or more compressors, an air-cooled condenser coil, and expansion devices. Propeller-type condenser fans draw outdoor air across the condenser coil.

Packaged Air-Cooled Chiller

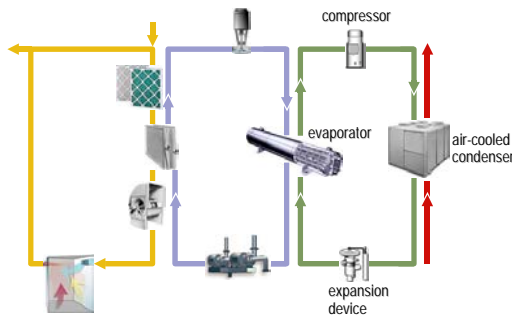

Figure 36

In the case of an air-cooled condenser, heat is transferred from the hot refrigerant vapor directly to the outdoor air without the need for a separate condenser-water loop.

As the heat-rejection requirement decreases, the quantity of air passing through the condenser coil(s) is reduced. This is accomplished by cycling the

period one

Dissecting HVAC Systems

notes

condenser fans on and off, or by modulating a damper or variable-speed drive on one or more of the fans.

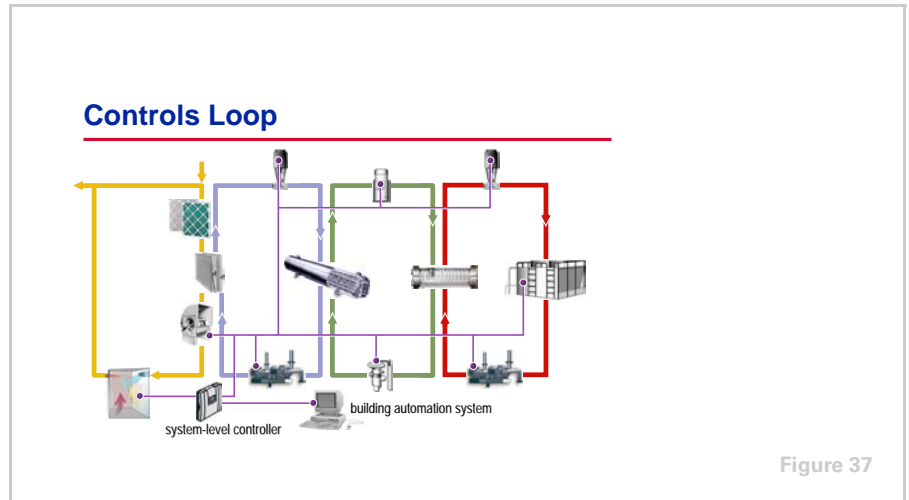

Controls Loop

The fifth, and final, loop of the HVAC system is the controls loop. Each of the previous four loops contains several components. Each component must be controlled in a particular way to ensure proper operation. Typically, each piece of equipment (which may be comprised of one or more components of a loop) is equipped with a unit-level, automatic controller.

In order to provide intelligent, coordinated control so that the individual pieces of equipment operate together as an efficient system, these individual unit-level controllers are often connected to a central, **system-level controller**.

Finally, many building operators want to monitor the system, receive alarms and diagnostics at a central location, and integrate the HVAC system with other systems in the building. These are some of the functions provided by a **building automation system (BAS)**.

period one
Dissecting HVAC Systems

notes

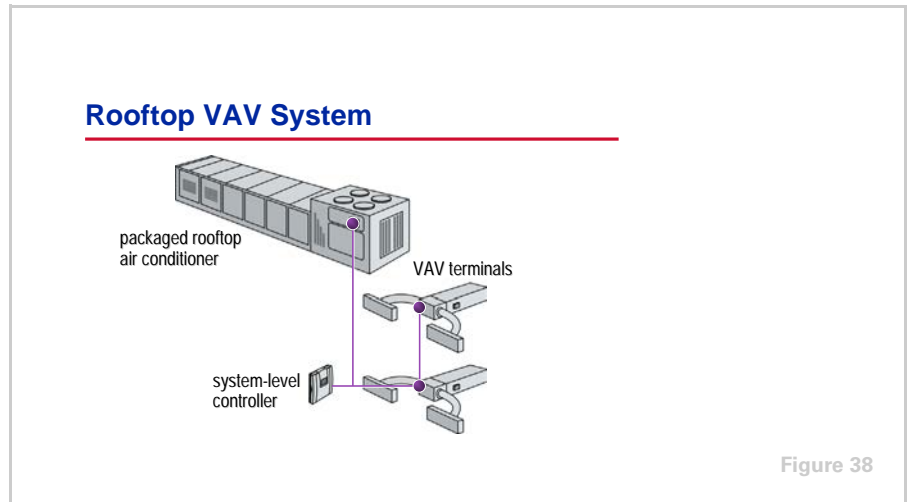

Figure 38 shows an example controls loop. This system uses a packaged rooftop air conditioner to deliver air to several VAV terminal units. This packaged rooftop air conditioner includes a unit-level controller that coordinates the operation of all components packaged inside this piece of equipment, such as the outdoor-air and return-air dampers, the supply and exhaust fans, the compressors, and the condenser fans.

In addition, each VAV terminal unit is equipped with a unit-level controller that directs its response to space conditions.

The system-level controller coordinates the operation of the VAV terminal units and the rooftop unit during the various modes of operation, such as occupied, unoccupied, and morning warmup.

period one
Dissecting HVAC Systems

notes

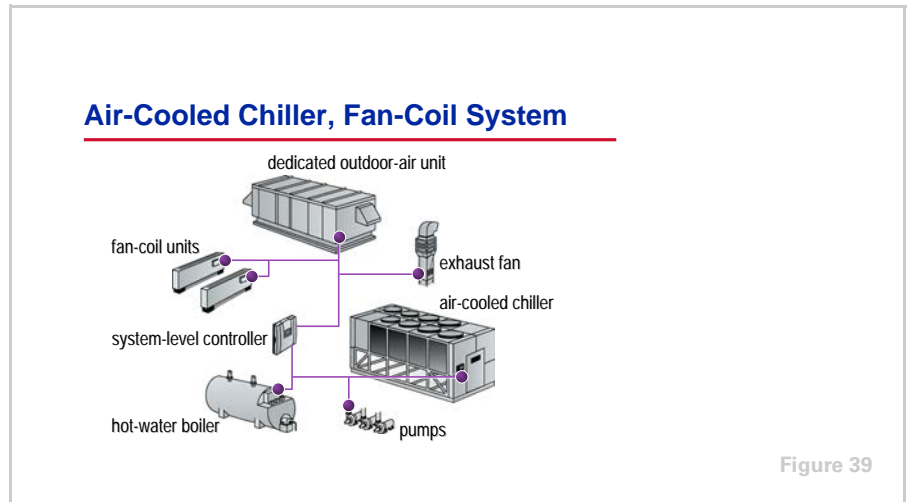

Figure 39 shows a second example controls loop. This system includes fan-coil units served by an air-cooled chiller and a hot-water boiler. A fan-coil unit is located in or near each conditioned space, and each one includes its own unit-level controller to modulate water flow through the coil in response to the changing load in the space. The unit-level controller on the air-cooled water chiller ensures the flow of chilled water whenever it is required, and the boiler controller ensures the flow of hot water whenever it is required. Finally, a dedicated outdoor-air unit conditions all of the outdoor air brought into the building for ventilation, before delivering it directly to the individual spaces.

In this example, a separate, system-level controller coordinates starting and stopping the pumps, the dedicated outdoor-air unit, and the stand-alone exhaust fan. It also determines when to change over from cooling to heating mode, and coordinates the operation of the chiller and boiler to prevent them from operating simultaneously.

period two

Direct-Expansion (DX) Versus Chilled-Water Systems

notes

Introduction to HVAC Systems

period two

Direct Expansion (DX) Versus Chilled-Water Systems

Figure 40

As mentioned in Period One, some HVAC systems have chilled water flowing through the tubes of the cooling coil. These systems are referred to as chilled-water systems. Other systems have cold, liquid refrigerant flowing directly through the tubes of the cooling coil. These are referred to as direct-expansion, or DX, systems.

Direct Expansion (DX)

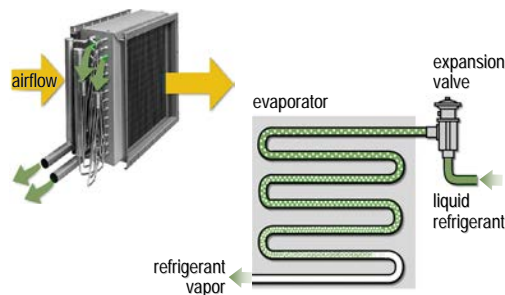

Figure 41

Direct-Expansion (DX) Systems

The term “direct” refers to the position of the evaporator with respect to the airside loop. In a **direct-expansion system**, the finned-tube cooling coil of the airside loop is also the evaporator of the refrigeration loop. The evaporator is in direct contact with the airstream.

The term “expansion” refers to the method used to introduce the refrigerant into the cooling coil. The liquid refrigerant passes through an expansion device just before entering the cooling coil (evaporator). This device, shown as an

period two

Direct-Expansion (DX) Versus Chilled-Water Systems

notes

expansion valve in Figure 41 on page 30, reduces the pressure and temperature of the refrigerant to the point where it is colder than the air passing through the coil.

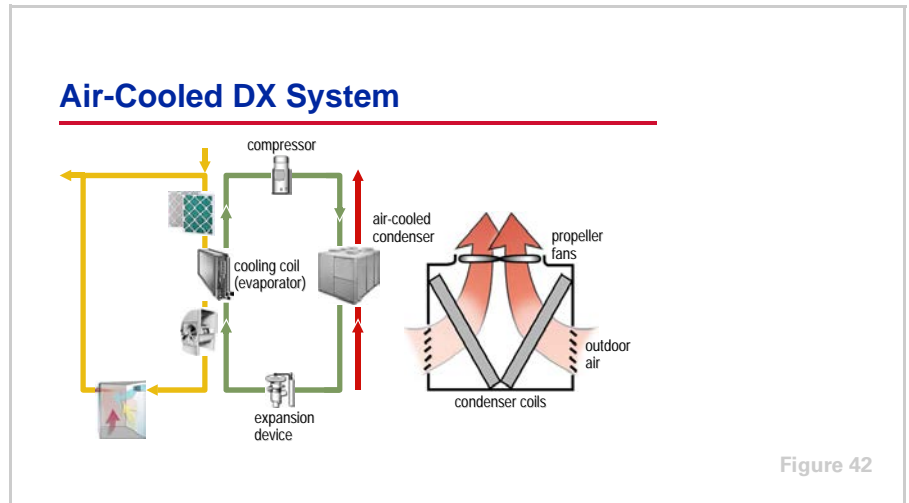

The primary difference between a chilled-water system and a direct-expansion system is that the DX system does not include the chilled-water loop. Instead, heat is transferred from the airside loop directly to the refrigeration loop.

Figure 42 shows an air-cooled DX system. In this case, the components of the heat-rejection loop are packaged together. The air-cooled condenser contains propeller-type fans that draw outdoor air across the finned-tube condenser coils. Heat is transferred from the hot refrigerant vapor directly to the outdoor air without the use of a separate condenser-water loop.

period two

Direct-Expansion (DX) Versus Chilled-Water Systems

notes

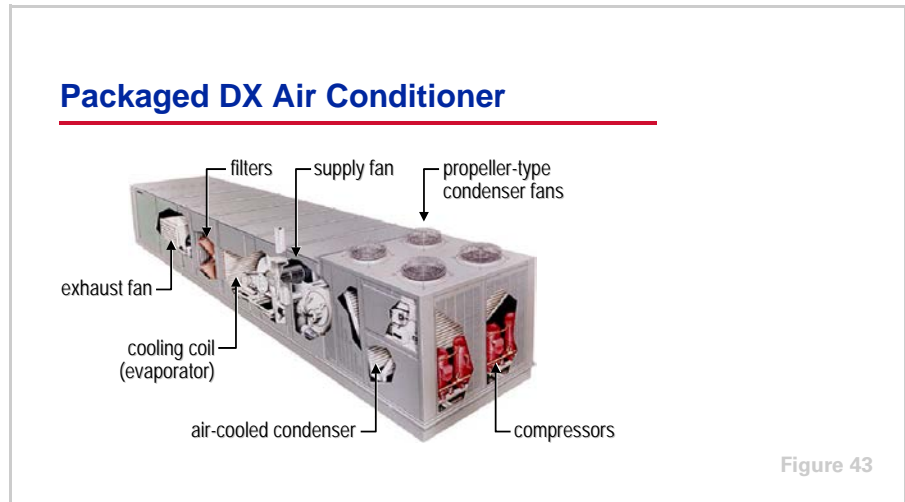

In a DX system, the components of the refrigeration loop may be packaged together or split apart. A packaged DX unit includes all the components of the refrigeration loop (evaporator, compressor, condenser, and expansion device) inside a single casing.

The packaged rooftop air conditioner was introduced in Period One. It combines several components of the airside loop with all the components of both the refrigeration and heat-rejection loops. This type of equipment is intended for outdoor installation, commonly on the roof of a building.

A major advantage of a packaged DX unit is the factory assembly and testing of all components, including the electrical wiring, the refrigerant piping, and the controls.

period two

Direct-Expansion (DX) Versus Chilled-Water Systems

notes



Figure 44

Alternatively, the components of the refrigeration loop may be split apart, allowing for increased flexibility in the system design. The example direct-expansion system shown in Figure 44 includes an air-cooled condensing unit (which includes compressors and a condenser packaged within a single casing) installed on the ground outside of the building, and a DX evaporator coil and expansion device installed in an air handler that is located inside the building. The components are connected by field-installed refrigerant piping.

It is important to recognize that the allowable distance between the components of a split system is limited to ensure reliable operation. Refrigerant does not flow like water. Refrigerant is in a vapor state during part of its cycle and in a liquid state during the remainder of its cycle. Oil, used to lubricate the compressor, is often carried along by the refrigerant as it flows throughout the system. The sizing and layout of the refrigerant piping is critically important in ensuring that the oil is returned to the compressor at the required rate. All components, including the refrigerant piping and controls, must be carefully selected to work properly over the desired range of operating conditions. For further information on refrigerant piping, see the *Refrigerant Piping Air Conditioning Clinic* (literature order number TRG-TRC006-EN).

A built-up DX system is one where none of the components are packaged together. This provides the system design engineer with complete flexibility to match components in order to achieve the desired performance. However, the responsibility falls on the system designer to ensure that the individual components will operate in a safe and reliable manner over the desired range of operating conditions. This requires a considerable amount of field design and installation expertise and time.

It is more common for a split DX system to have two or more components packaged together by the manufacturer. One example is the air-cooled condensing unit, and another is a package that includes the compressors, the DX evaporator coil, and the expansion devices.

period two

Direct-Expansion (DX) Versus Chilled-Water Systems

notes

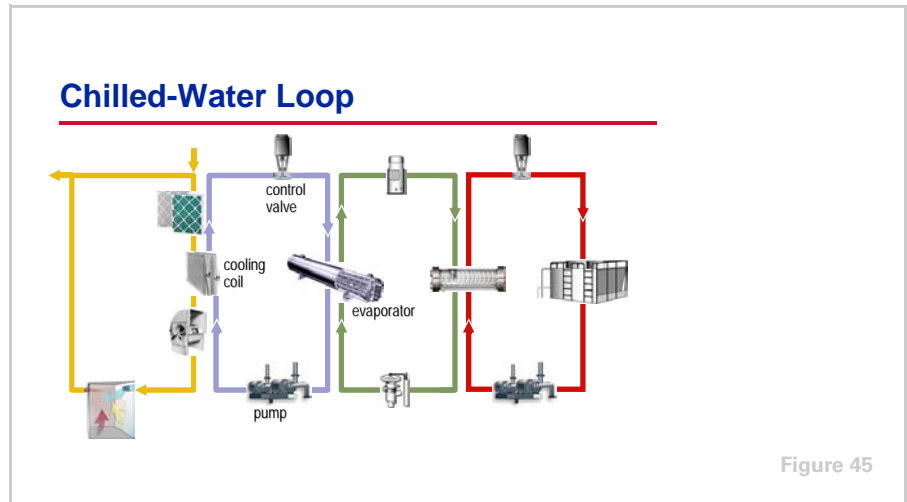

Chilled-Water Systems

In a **chilled-water system**, the chilled-water loop transports heat energy between the airside loop and the refrigeration loop. As described in Period One, it is comprised primarily of a cooling coil, a circulating pump, an evaporator, a control valve, and interconnecting piping.

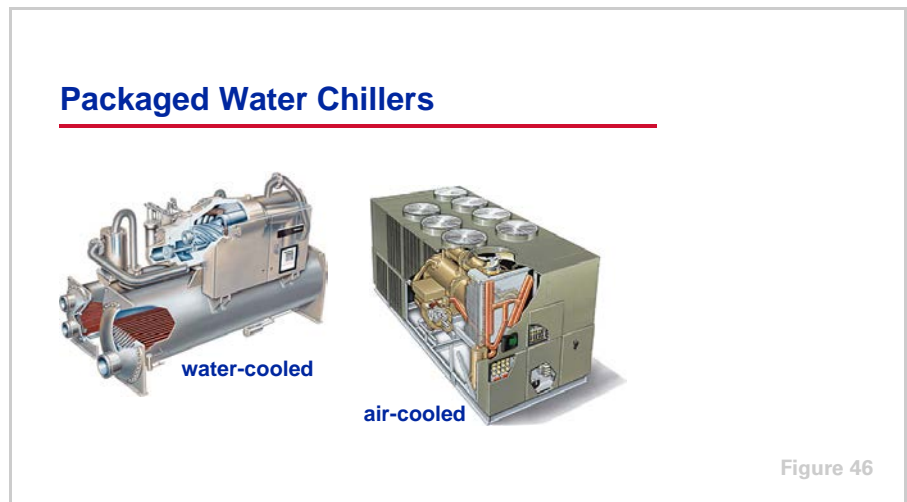

In a chilled-water system, the components of the refrigeration loop (evaporator, compressor, condenser, and expansion device) are often manufactured, assembled, and tested as a complete package within the factory. This type of equipment is called a “packaged” water chiller, and may include either a water-cooled condenser or an air-cooled condenser. The components are selected and optimized by the manufacturer, and the performance is tested as a complete assembly, rather than as individual components.

period two

Direct-Expansion (DX) Versus Chilled-Water Systems

notes

A major advantage of this configuration is factory assembly and testing of all chiller components, including the electrical wiring, the refrigerant piping, and the controls. This eliminates field labor and often results in faster installation and improved reliability.

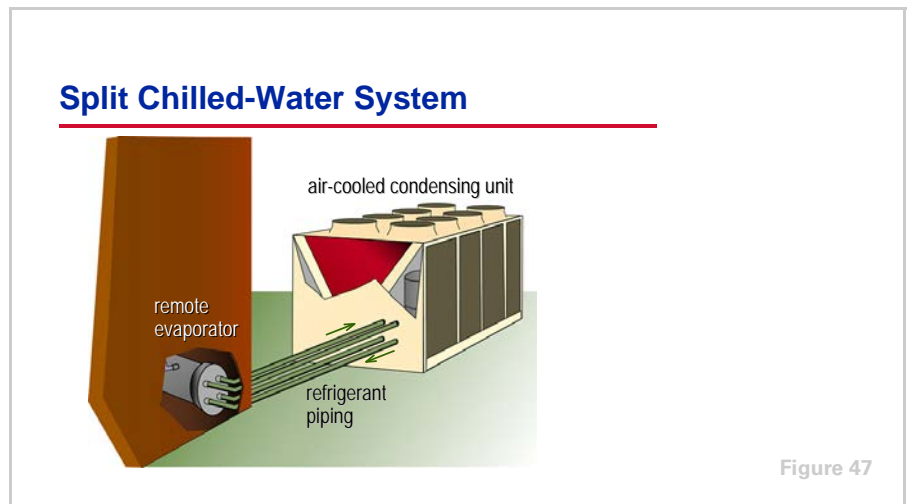

Alternatively, the components of the refrigeration loop may be split apart. While water-cooled chillers are rarely installed as separate components, some air-cooled chillers offer the flexibility of separating the components for installation in different locations. This flexibility allows the system design engineer to place the components where they best serve the space, acoustic, and maintenance requirements of the building owner.

The example chilled-water system shown in Figure 47 includes a packaged, air-cooled condensing unit installed outdoors, next to the building. The other components of the refrigeration loop (evaporator and expansion device) are installed inside the building. These components are connected to the condensing unit with field-installed refrigerant piping. This configuration places the part of the system that is susceptible to freezing (evaporator and water piping) indoors, and the primary noise-generating components of the refrigeration loop (compressors and condenser fans) outdoors. This usually eliminates any requirement to protect the chilled-water loop from freezing during cold weather. Of course, consideration should be given to potential noise problems caused by the outdoor components. This configuration is particularly popular in schools and other institutional facilities, primarily due to reduced seasonal maintenance for freeze protection.

A drawback of splitting the components is the requirement for field-installed refrigerant piping. The possibility of system contamination and leaks increases when field-installed piping and brazing are required. Additionally, the components must be properly selected to work together over the desired range of operating conditions. With a packaged water chiller, the selection of the components, and the design and installation of the refrigerant piping, is handled by the manufacturer in the factory.

period two

Direct-Expansion (DX) Versus Chilled-Water Systems

notes

DX versus chilled water

Factors Affecting the Decision



- Installed cost
- Energy consumption
- Space requirements
- Freeze prevention
- Building height, size, shape
- System capacity
- Centralized maintenance
- Stability of control
- Individual tenant billing

Figure 48

Factors Affecting the Decision

There are several considerations when deciding whether to use a direct-expansion system or a chilled-water system.

One of the most common reasons for selecting a DX system, especially a packaged DX system, is that, in a smaller building, it can frequently have a lower installed cost than a chilled-water system.

Installed Cost

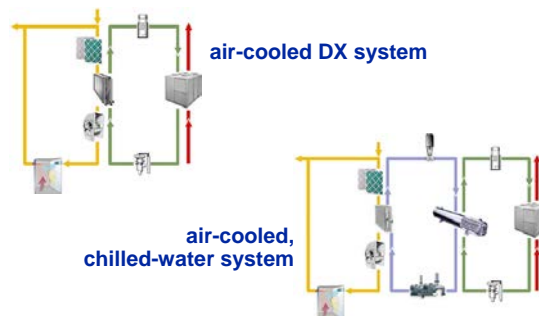

Figure 49

Figure 49 compares the loops of an air-cooled DX system with the loops of an air-cooled, chilled-water system. In the DX system, the chilled-water pumps, the control valves, the piping, and related accessories are eliminated.

Packaged DX equipment generally requires less field labor and materials to install. Also, many of the system-level control functions can be packaged along with the unit-level control functions in the same piece of control hardware. This

period two

Direct-Expansion (DX) Versus Chilled-Water Systems

notes

can reduce the amount of time it takes to design, install, and commission the control system.

If a split DX system is used, there is an added cost for designing and installing the refrigerant piping and controls.

If choosing to use packaged components in a DX system, the HVAC system designer defers many design decisions to the manufacturer. This can reduce the initial cost of the equipment, but the limitations of a fixed design may make it difficult for the equipment to meet certain requirements of the system.

Sometimes, a chilled-water system can actually be the lower-cost alternative for meeting the requirements of a particular application.

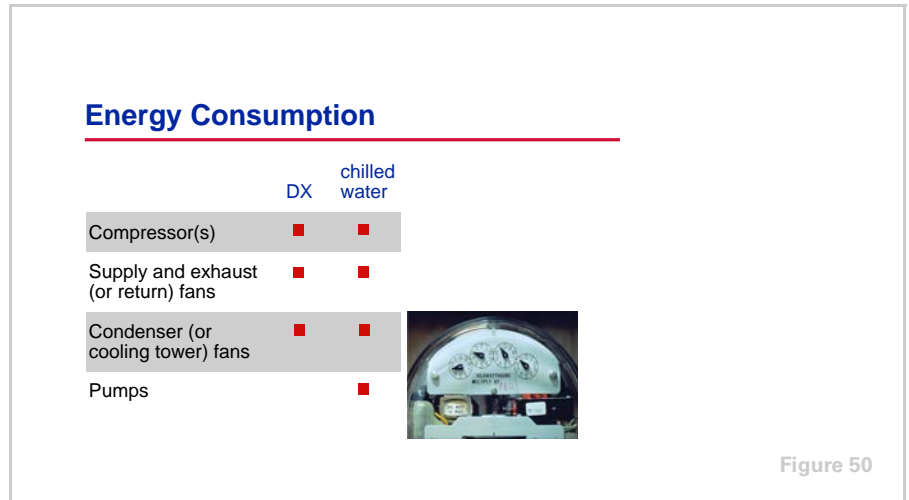

However, decisions based solely or primarily on installed cost often ignore ongoing costs, such as energy, maintenance, and replacement costs. Life-cycle cost includes the total cost of owning and operating the HVAC system over a specified period of years.

A DX system does not have the added energy use of the pumps, but the larger compressor on the water chiller is often more efficient than the compressor in the DX unit. Performing a comprehensive energy analysis is the best method of estimating the life-cycle cost difference between DX and chilled-water systems. Software tools are available to help the HVAC system designer analyze various HVAC systems based on life-cycle cost.

period two

Direct-Expansion (DX) Versus Chilled-Water Systems

notes

Space Requirements



Figure 51

Another common reason for selecting a DX system is limited space available for indoor equipment rooms. Water-cooled, chilled-water systems frequently require indoor equipment rooms to house the chillers and pumps. Air-cooled, chilled-water systems require less space indoors, but may still need space for the evaporator and/or pumps. Indoor equipment rooms reduce the amount of usable or rentable floor space.

Many DX systems are packaged and use air-cooled condensers, so that they can be located on the roof of a building, in a small equipment room, or even within the perimeter wall of the building (like the PTAC unit described in Period One). As demonstrated earlier in this period, split DX systems may have some components installed indoors as well.

Freeze Prevention

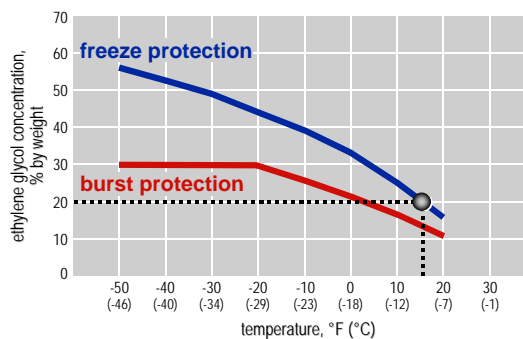

Figure 52

In many climates, the outdoor temperatures drop below 32°F (0°C) at some point during the year. Systems that contain water are at risk of freezing when

period two

Direct-Expansion (DX) Versus Chilled-Water Systems

notes

the piping or other components of the chilled-water loop are exposed to these cold ambient temperatures, or if the refrigeration equipment cools the water to a temperature below 32°F (0°C). Air-cooled DX systems, however, use refrigerant as the heat-transfer media and are not at risk for freezing under these conditions.

A common approach used to prevent freezing in a chilled-water system is to use a mixture of water and antifreeze, such as ethylene glycol or propylene glycol. This lowers the freezing point of the fluid mixture. The chart in Figure 52 on page 38 shows the freezing point for various concentrations of water-and-ethylene-glycol solutions. For example, if 20 percent (by weight) of the solution is ethylene glycol and 80 percent is water, the temperature at which this mixture will begin to freeze is 15.5°F (-9.1°C), compared to 32°F (0°C) for pure water.

It is important to note that adding glycol to the chilled-water system results in less-efficient heat transfer. As a consequence, larger refrigeration equipment and an increase in the heat-transfer surface of the cooling coils may be required to achieve the required capacity. Also, the viscosity of a water-glycol solution increases at low temperatures. Therefore, additional pumping power is required to move the solution through the entire chilled-water loop. Ethylene glycol is most-commonly used in comfort-cooling applications, because it has less of an impact on heat transfer and pumping power than propylene glycol. Propylene glycol is frequently used in food or pharmaceutical applications, because it is non-toxic if ingested.

Realize also that there are two levels of freeze protection: burst protection and freeze protection. As the temperature drops below the freezing point of the solution, ice crystals begin to form. Because the water freezes first, the remaining water-glycol solution is further concentrated and remains in the liquid phase. The combination of ice crystals and remaining water-glycol solution makes a flowable slush, but the volume increases as this slush forms. If the chilled-water loop has an expansion tank large enough to accommodate this increase in volume, and if the water-glycol solution does not need to be pumped during below-freezing weather, burst protection is usually sufficient to prevent damage to the system. If the chilled-water loop does not have adequate expansion volume, or if the water-glycol solution must be pumped during below-freezing weather, freeze protection is probably required.

period two

Direct-Expansion (DX) Versus Chilled-Water Systems

notes

Building Height, Size, Shape



Figure 53

The size and shape of the building may also play an important role in selecting between a chilled-water system and a DX system. High-rise buildings are often not well-suited for packaged DX rooftop equipment because of the long distances that supply air must be transported. The physical size of the equipment and ductwork, and the high static-pressure requirements of the long duct runs, often limit the use of packaged DX rooftop equipment to shorter buildings.

In split systems (DX or chilled water), the allowable distance between the refrigeration components is limited to ensure reliable operation. Consult the manufacturer for maximum allowable length of the interconnecting refrigerant piping.

Chilled-water systems are ideal for applications where the refrigeration equipment is centrally located within a building, or among a campus of buildings, and the cooling loads are remote. The water can be cooled at one location and then transported long distances through the chilled-water piping. Also, chilled-water piping is generally easier to design and install than refrigerant piping.

period two

Direct-Expansion (DX) Versus Chilled-Water Systems

notes

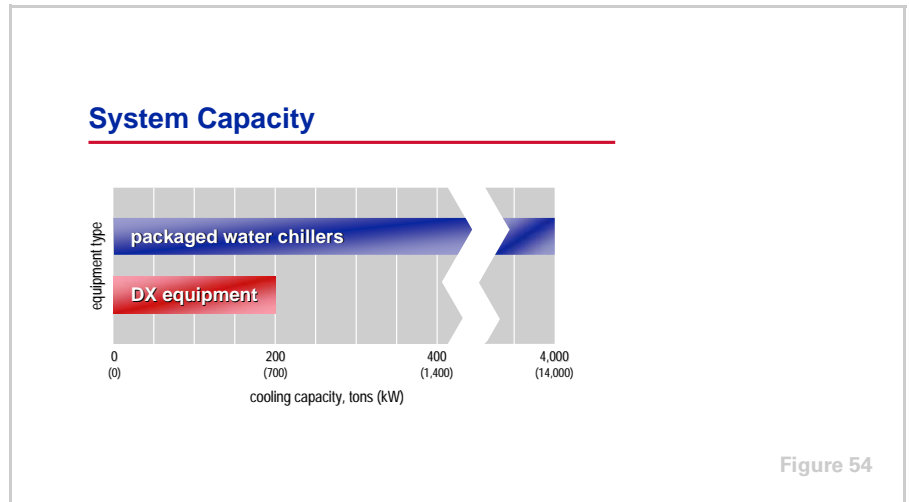

The required cooling capacity of the system can also influence the decision. Packaged water chillers are typically available in sizes ranging from 7.5 to approximately 4,000 tons (25 to 14,000 kW). Direct-expansion equipment is typically available in sizes ranging from 1 to 200 tons (3.5 to 704 kW).

In large buildings, a chilled-water system generally consists of fewer pieces of refrigeration equipment than a DX system. Consider, for example, a school with a design cooling capacity of 200 tons (704 kW). A chilled-water system may be designed using a single 200-ton (704-kW) water chiller. However, a DX system serving that same school may consist of five 40-ton (140-kW) or forty 5-ton (17.5-kW) packaged rooftop units. The number of pieces of equipment impacts the maintenance requirements.



Having the refrigeration equipment centralized generally allows easier access for preventive maintenance and service. In addition, in most water-cooled

period two

Direct-Expansion (DX) Versus Chilled-Water Systems

notes

chilled-water systems, the compressors are located inside the building, which often allows easier access for service.

Another benefit of a chilled-water system is refrigerant containment. Having the refrigeration equipment installed in a central location minimizes the potential of refrigerant leaks, simplifies refrigerant handling practices, and typically makes it easier to contain a leak if one does occur.

If there is a change in the use of the building, or if the system is to be expanded, chilled water can usually be obtained by tapping into the main chilled-water loop. Clearly, the ideal time to consider the possibility of future expansion is during the initial design of the system.

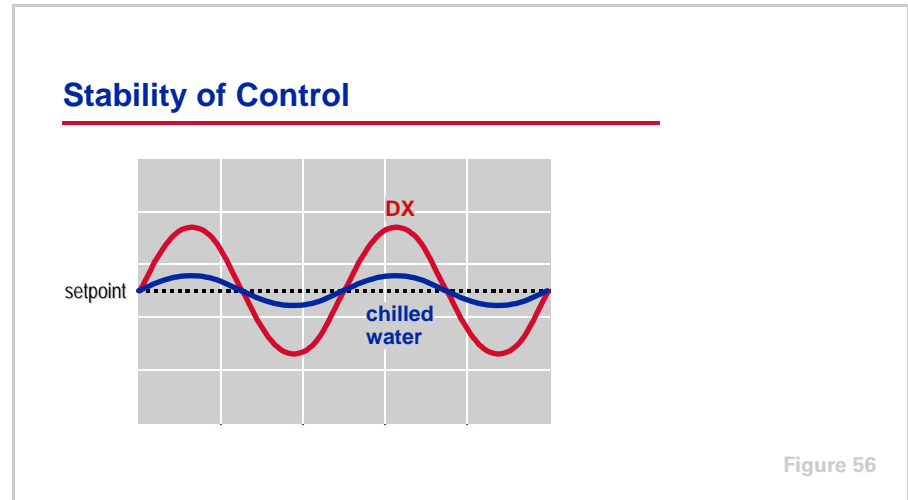

Chilled-water systems generally offer more-stable control than DX systems. DX equipment typically uses multiple, discrete steps of capacity unloading. For example, a 110-ton (387-kW) rooftop unit may contain eight scroll compressors and have four specific steps of capacity control. A comparable air-cooled water chiller may contain two helical-rotary (screw) compressors, each with a slide valve for capacity control that allows for smooth unloading.

In addition, the large volume of water inside the chilled-water loop provides a thermal buffer that dampens any changes to the cooling load. The effects of varying the capacity of the water chiller are not typically experienced as quickly as the effects of varying the capacity of a DX system.

period two

Direct-Expansion (DX) Versus Chilled-Water Systems

notes



Figure 57

If the building will have multiple tenants that desire separate HVAC systems, packaged DX systems are often selected. For a building that contains a central chilled-water system, if an individual tenant requires cooling after hours, the chiller and pumps would need to turn on. However, for a building that contains multiple packaged DX units, such as rooftop or self-contained units, only the unit serving that tenant would need to turn on.

If the tenants are paying the utility bills, individual packaged DX units may make it easier to track energy use by tenant. If the building owner is paying the utility bills, a building automation system can be used to track after-hours energy usage by tenant, allowing the building owner to bill for after-hours HVAC operation.

period three

Common HVAC System Types

notes

Introduction to HVAC Systems

period three

Common HVAC System Types

Figure 58

This period will introduce several common HVAC systems. The intent is not to discuss every possible system or equipment configuration, nor is it to suggest which system to choose for a given application. The intent is to familiarize you with a variety of common system types.

System Categories

zones served by supply fan	single zone constant volume	single zone variable volume
	multiple zone constant volume	multiple zone variable volume
	air volume delivered by supply fan	

Figure 59

For the purpose of this discussion, systems will first be classified according to whether the supply fan delivers air to a single thermal zone or to multiple zones. A zone may be either a single conditioned space, or a group of spaces that react thermally in a similar manner over time and which is governed by a single thermostat. An example of a zone may be several classrooms that are along the east face of a building.

Within each of these categories, systems will be further classified by whether the supply fan delivers a constant volume or a variable volume of air.

period three

Common HVAC System Types

notes

Note that the classification of a particular system in this period may not apply to how that system is used in every application. For example, a chilled-water terminal system (such as a classroom unit ventilator) is classified here as a single-zone, constant-volume system because the supply fan delivers air to a single thermal zone and the fan is typically a constant-volume device. In some systems, however, the unit ventilators may have the capability to operate at multiple fan speeds.

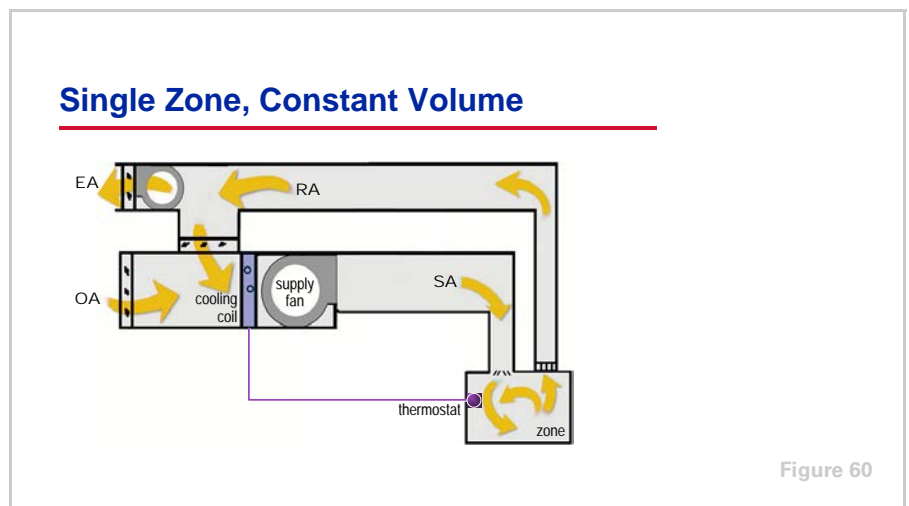

Single-Zone Systems

A **single-zone, constant-volume system** delivers a constant quantity of air to a single, temperature-controlled zone. The thermostat measures the dry-bulb temperature within the zone and compares it to the desired setpoint. In response to a deviation from that setpoint, the thermostat sends a signal to vary the cooling or heating capacity of the system.

Because the supply fan delivers a constant quantity of air to the zone, this reduction in cooling or heating capacity varies the temperature of the supply air at part-load conditions.

period three

Common HVAC System Types

notes

single-zone systems

Single Thermostat



Figure 61

If the zone is comprised of multiple conditioned spaces, the space in which the thermostat is located dictates the operation of the HVAC system. All other spaces must accept the resulting level of comfort based on the space containing the thermostat. If the thermostat calls for more cooling, all spaces get more cooling.

Therefore, in a building with this type of system, it is common to use several single-zone systems to satisfy the different thermal requirements of the building.

single zone, constant volume

Packaged Terminal Air Conditioner

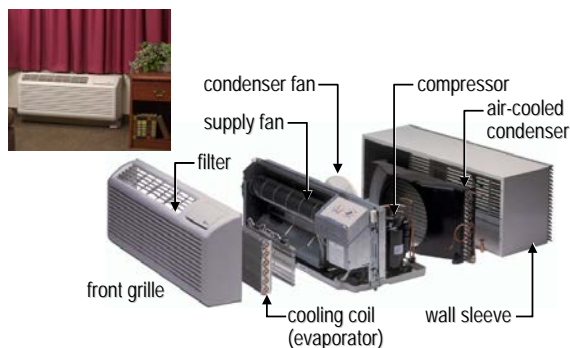

Figure 62

A simple example of a single-zone, constant-volume system is a **packaged terminal air conditioner (PTAC)**. Refer to Figure 62. This type of equipment contains several components of the airside loop and all the components of the refrigeration, heat-rejection, and controls loops inside a common casing.

period three

Common HVAC System Types

notes

PTAC units are typically installed in the perimeter wall of the building, which allows the air-cooled condenser to reject heat directly to the outdoors. They are commonly used in hotels, dormitories, nursing homes, and apartments.

In this example PTAC, return air from the occupied space is drawn in through the front grille, and passes through a filter and DX cooling coil before the supply fan discharges the air from the top of the unit directly into the occupied space. Outdoor air for ventilation can enter through a separate damper and mix with the recirculated air, or it can be delivered to the conditioned space by a dedicated outdoor-air ventilation system.

Packaged inside this same piece of equipment is a compressor, air-cooled condenser coil, condenser fan, expansion device, and all the controls.

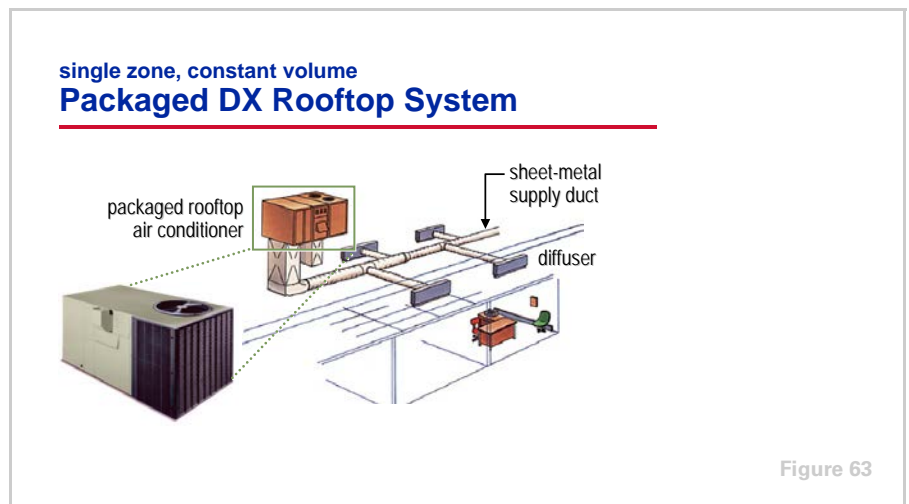

Another example of a single-zone, constant-volume system (Figure 63) is a **packaged DX rooftop unit**. Like the PTAC, this unit includes several components of the airside loop, all the components of the refrigeration and heat-rejection loops, and most of the components of the controls loop, inside a common casing. The conditioned air, however, is discharged from the unit into the supply ductwork and is delivered to the occupied space(s) through supply diffusers.

As the name implies, this type of equipment is typically installed on the roof of the building, which allows the air-cooled condenser to reject heat directly to the outdoors.

Because so many of the system components are packaged in a single casing, systems that use rooftop units may require less field labor and materials to install than other system types. Single-zone rooftop units are commonly used in a wide variety of buildings, however, they are not often well-suited for high-rise buildings because of the long distances that supply air must be transported.

period three
Common HVAC System Types

notes

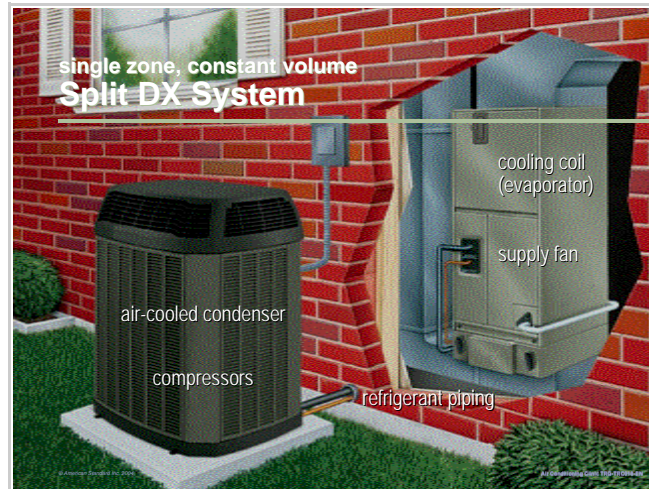

Figure 64

A slight variation of this system involves splitting up the components of the refrigeration loop. In the example in Figure 64, a single-zone, constant-volume air handler is installed in a mechanical closet adjacent to the conditioned space. This air handler includes several components of the airside loop, including a DX cooling coil (evaporator). The compressor and air-cooled condenser are packaged together and installed outdoors on the ground next to the building.

This arrangement is called a **split DX system** because the components of the refrigeration loop are split apart and connected by field-installed refrigerant piping. Note that the allowable distance between the components of a split system is limited to ensure reliable operation.

Splitting the components allows for greater flexibility in the system design, but requires careful attention to the design and installation of refrigerant piping in the field.

period three

Common HVAC System Types

notes

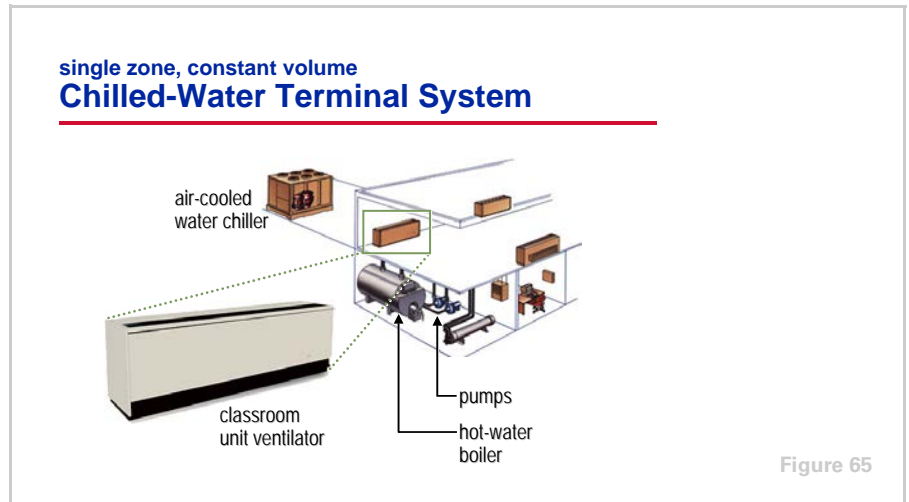

Single-zone, constant-volume systems may also use chilled water as the cooling media. In the case of this **chilled-water terminal system**, chilled water and hot water are produced at a central location and pumped throughout the building to individual terminal units that are installed in or near each zone. Examples of chilled-water terminal units include fan-coil units, classroom unit ventilators, and blower-coil units.

In Figure 65, an air-cooled water chiller is located outdoors next to the building, and a hot-water boiler is located in the basement. A classroom unit ventilator is installed within each conditioned space. Each unit ventilator contains outdoor- and return-air dampers, a filter, a supply fan, heating and cooling coils, and controls inside a common casing. The supply air is discharged directly into the conditioned space.

As an alternative, chilled-water terminal units could be installed in the ceiling plenum, or in a closet adjacent to the conditioned space, with ductwork and diffusers used to deliver air to the zone.

This chilled-water terminal system is classified as a single-zone system because the supply fan in each terminal unit delivers air to a single thermal zone. As mentioned earlier, the supply fan is typically a constant-volume device. In some systems, however, the terminal units may have the capability to operate at multiple fan speeds.

period three

Common HVAC System Types

notes

single zone, constant volume

Four-Pipe Versus Two-Pipe System

	4-pipe	2-pipe
Coils per terminal unit	2	1
Water distribution piping	2 sets	1 set
Heating and cooling	either or both simultaneously	mutually exclusive
Temperature control	direct	direct
Humidity control	direct (if heating coil downstream of cooling coil)	indirect

Figure 66

The heating coil used in chilled-water terminal units may use hot water or steam that is produced centrally, or the heat may be provided by an electric heating coil installed inside the terminal unit. When hot water is used, the system may be configured as either a four-pipe system or a two-pipe system.

In a four-pipe system, each terminal unit contains two separate coils with control valves, one for cooling and one for heating. Two sets of water distribution pipes are installed throughout the building. One set of pipes transports chilled water from the water chiller to each terminal unit and then returns it to the chiller. The other set transports hot water from the boiler to each terminal unit and then returns it to the boiler. As long as both the chiller and the boiler are turned on, a four-pipe system can provide for coincident heating or cooling throughout the building. In other words, chilled water can be supplied to a terminal unit in a zone that requires cooling, at the same time that hot water is being supplied to a different terminal unit in a zone that requires heating.

Furthermore, if the heating coil is located downstream from the cooling coil, a four-pipe system can also allow direct, independent control of both temperature and humidity in the conditioned space. In this configuration, the terminal unit can overcool (to dehumidify) the supply air and then temper (reheat) the air to avoid overcooling the space.

In a two-pipe system, each terminal unit contains only one coil, which can be used for either cooling or heating. Only one set of water distribution pipes is installed throughout the building. This set of pipes can either supply chilled water from the water chiller or hot water from the boiler, but not both at the same time. In other words, when the chiller is turned on, only chilled water is available to all of the terminal units. If an individual terminal unit requires heating, hot water is not available.

A two-pipe system is typically less expensive to install, because only one set of pipes is installed throughout the building and each terminal unit contains only one coil and one control valve. However, providing acceptable comfort to all

period three

Common HVAC System Types

notes

zones of the building can be a challenge, particularly during the spring and fall seasons when some zones need heating while others need cooling.

A popular strategy for improving the ability of a two-pipe system to provide comfort to all zones of the building is to include an electric resistance-heating coil in each terminal unit. During the spring, summer, and fall seasons, the system delivers chilled water to all of the terminal units and the electric heat can be energized if necessary to avoid overcooling any particular zone. During the winter season, the system switches over and delivers hot water to all of the terminal units.

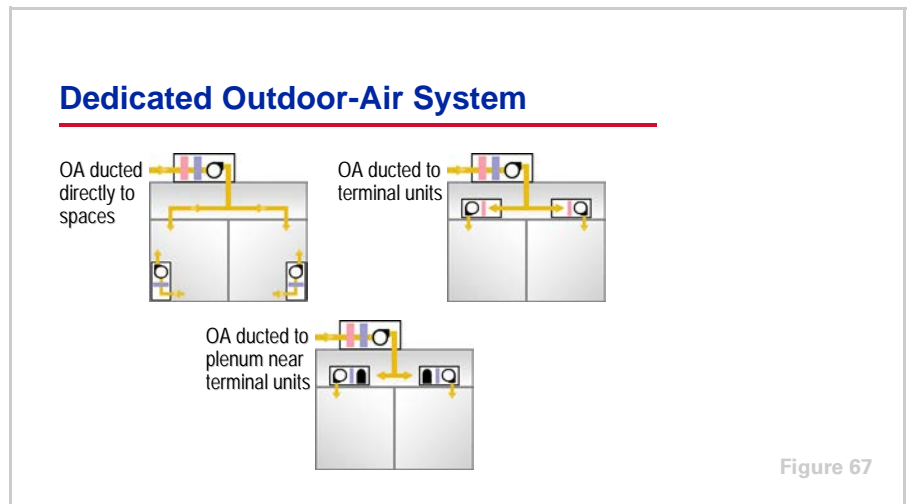

When the terminal units are installed around the perimeter of a building, outdoor air can be brought in through a separate damper and mixed with recirculated return air before being delivered directly to the zone. This outdoor-air damper can also allow for an airside economizer cycle when the outdoor air is cool enough to provide free cooling.

In some cases, however, all of the outdoor air for a group of zones is conditioned by a separate, **dedicated outdoor-air system**. The outdoor air is filtered, cooled, dehumidified, heated, or humidified by the dedicated outdoor-air unit, and then delivered either directly to each zone or to the inlet of each terminal unit.

While the use of a dedicated outdoor-air system is somewhat common in chilled-water terminal systems, this concept can also be used with other types of HVAC systems.

period three

Common HVAC System Types

notes

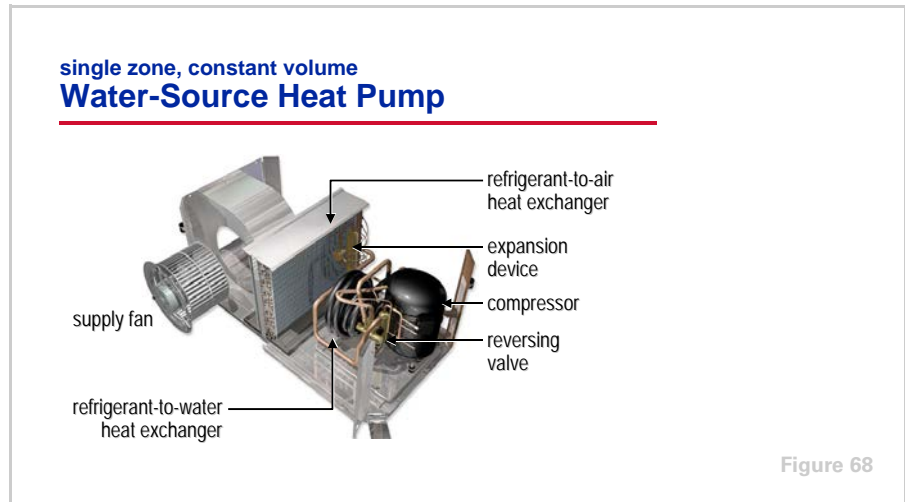

Another example of a single-zone, constant-volume system (shown in Figure 68) is one that uses a **water-source heat pump (WSHP)**. A WSHP is a packaged DX unit with a water-cooled condenser. It includes several components of the airside loop, all the components of the refrigeration loop, and many components of the control loop, inside a common casing.

The refrigeration cycle is reversible, allowing the heat pump to provide heating with the same components that also provide cooling. During the cooling mode, the refrigerant-to-air heat exchanger functions as the evaporator, and transfers heat from the airstream to the refrigerant, cooling the supply air. The refrigerant-to-water heat exchanger functions as the condenser, and transfers heat from the refrigerant to the water flowing through it.

In the heating mode, a reversing valve permits the WSHP to change over to heating operation. The refrigerant-to-air heat exchanger now functions as the condenser, and transfers heat from the refrigerant to the airstream, heating the supply air. The refrigerant-to-water heat exchanger functions as the evaporator, and transfers heat from the water to the refrigerant.

This system is classified as a single-zone system because the supply fan in each heat pump delivers air to a single thermal zone.

period three

Common HVAC System Types

notes

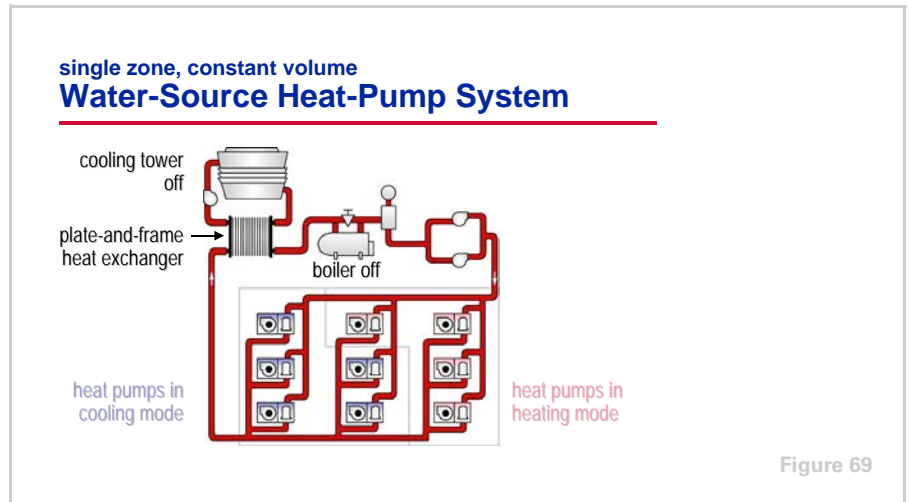

In a traditional WSHP system, all the heat pumps are connected to a common water loop. A cooling tower and a hot-water boiler are also installed in this loop to maintain the temperature of the water within a desired range.

When all of the heat pumps are in the cooling mode, the water in the loop heats up. The cooling tower rejects heat to keep the loop from getting too warm. When all of the heat pumps are in the heating mode, the water in the loop cools down. The boiler adds heat to keep the loop from getting too cold.

At many times during the year, some heat pumps in the building may operate in the cooling mode while others may simultaneously operate in the heating mode. As an example, during the fall season, some interior zones require cooling while some of the perimeter zones require heating. The heat rejected to the water loop, by the heat pumps that are operating in the cooling mode, helps keep the temperature of the water loop warm enough to provide heat for the heat pumps that are operating in the heating mode. During these times, both the cooling tower and boiler can be shut off, saving energy.

period three

Common HVAC System Types

notes

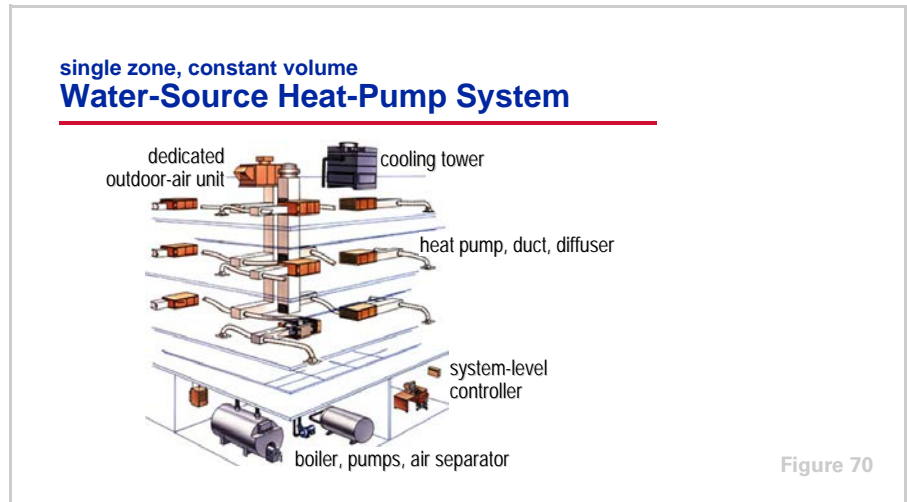

In Figure 70, a water-source heat pump is installed in the ceiling plenum above each zone. The conditioned supply air from each unit is discharged into supply ductwork and delivered to the zone through diffusers. Water-source heat pumps can also be located directly in the conditioned space, in a closet adjacent to the space, or on the roof.

The cooling tower is located on the roof, and the hot-water boiler and pumps are located in the basement. For most water-source heat-pump systems, the outdoor air required for ventilation is conditioned by a dedicated outdoor-air unit, and delivered either directly to each zone or to the ceiling plenum near the inlet of each heat pump.

period three

Common HVAC System Types

notes

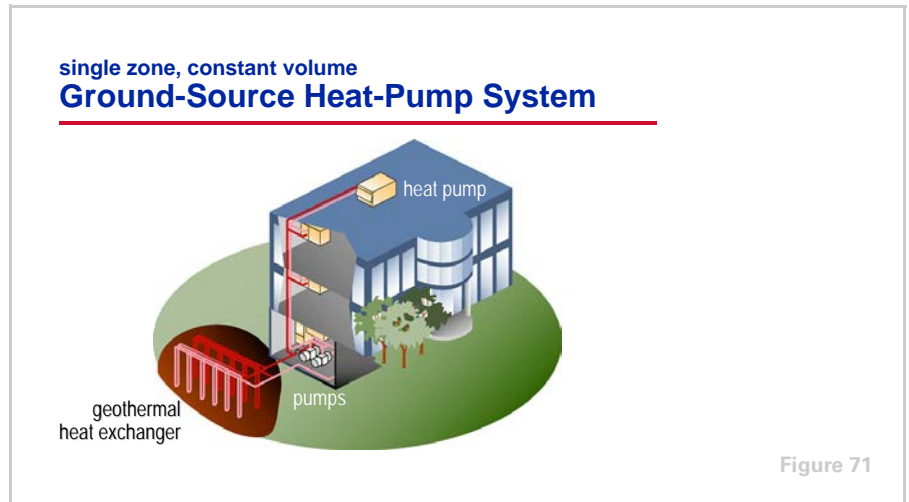

In the previous example, a cooling tower and a boiler were connected to the common water loop to maintain the temperature of the loop within a desired range. A variation of this system (Figure 71) takes advantage of the relatively constant temperature of the earth, and uses the ground (geothermal heat exchanger) instead of the cooling tower and boiler.

These systems, often referred to as **ground-source heat-pump systems**, do not actually get rid of heat—they store it in the ground for use at a different time. During the summer, the heat pumps absorb heat from the building and store it in the ground. When the building requires heating, this stored heat can be recaptured from the ground.

In a properly designed ground-source heat-pump system, no cooling tower is necessary. From an architectural perspective, this allows all the heat from the building to be rejected without any visible sign of a cooling tower. Also, if the heat pumps can satisfy all building heating requirements, no boiler is necessary, saving initial cost and floor space.

Ground-source heat-pump systems offer the potential for operating-cost savings when compared to the traditional cooling-tower-and-boiler system. However, installation costs may be higher due to the geothermal heat exchanger.

period three

Common HVAC System Types

notes

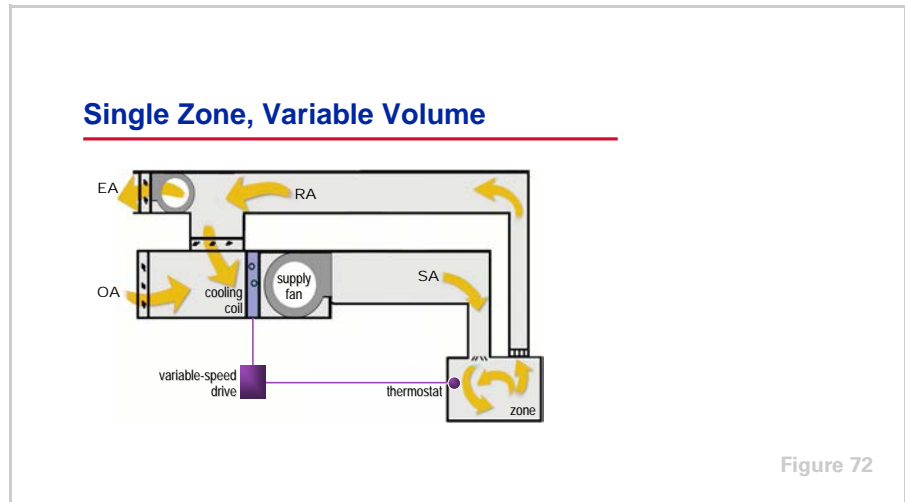

So far, all of the single-zone systems discussed typically use a constant-volume supply fan. A **single-zone, variable-volume (VAV) system** varies the quantity of constant-temperature air delivered to one temperature-controlled zone. Again, a zone may be either a single space, or a group of spaces that react thermally in a similar manner over time, and are governed by one thermostat.

In response to a reduced cooling load, a thermostat located in the zone instructs the supply fan to reduce capacity, thus reducing supply airflow. Cooling capacity is modulated to maintain a constant supply-air temperature. Unlike a traditional multiple-zone VAV system, the single-zone VAV system uses no VAV terminal boxes to vary airflow to the zone. Instead, fan capacity is modulated in direct response to the zone thermostat.

Single-zone VAV systems are most-commonly used to serve large zones with highly variable cooling loads. Examples include arenas, gymnasiums, assembly halls, large meeting rooms, and cafeterias. Many different equipment types could be configured to operate as a single-zone VAV system. A common example is a packaged DX rooftop unit that delivers conditioned supply air through ductwork and multiple diffusers into a single, large zone.

period three

Common HVAC System Types

notes

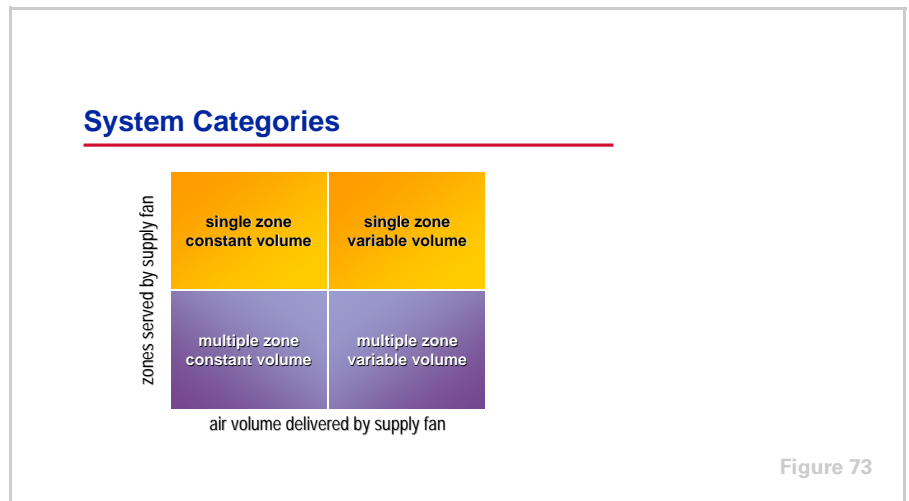

Multiple-Zone Systems

The previous section discussed systems in which the supply fan delivers air to a single thermal zone. This next section will discuss systems in which the supply fan delivers air to multiple, individually controlled thermal zones.

Again, within this multiple-zone category, systems will be further classified by whether the supply fan delivers a constant volume or a variable volume of air.

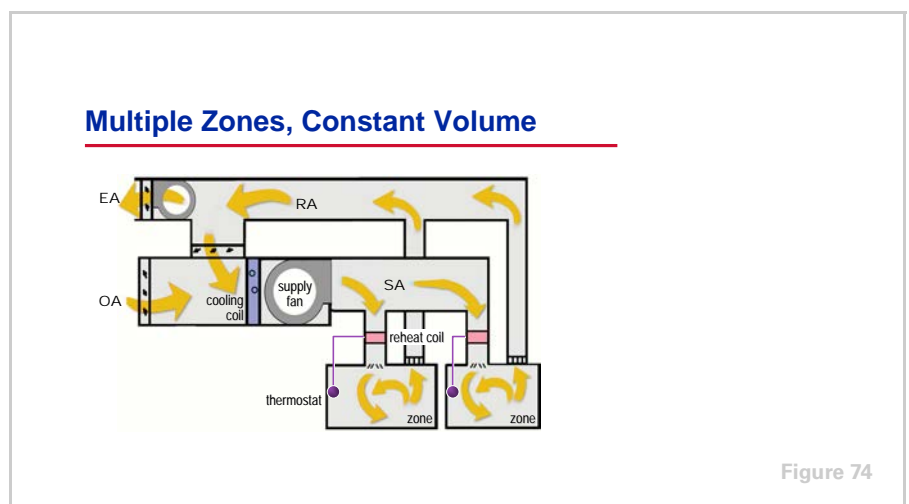

A **multiple-zone, constant-volume system** uses a central supply fan and cooling coil to deliver a constant quantity of air to several individually controlled zones. The central cooling coil cools and dehumidifies the supply air to a particular leaving-air temperature. In some systems, this temperature is constant; in others, it varies throughout the day and year based on a particular external condition, such as outdoor temperature.

period three

Common HVAC System Types

notes

Because the cooling loads of the individual zones often vary significantly, the temperature of the supply air will often likely be too cold for some zones, causing those zones to overcool. The air being delivered to these zones is either reheated, or mixed with a separate warm airstream, to produce a warmer supply-air temperature that offsets the cooling load of that zone without overcooling.

Figure 74 on page 57 shows a schematic of a **terminal reheat system**. During the cooling season, the central supply fan and cooling coil deliver a constant quantity of cold air to all the zones. Each zone has a dedicated heating coil that is used to reheat the air before it is delivered to the respective zone. A thermostat located in the zone modulates the capacity of the reheat coil, thereby varying the temperature of the air delivered to that zone.

The terminal reheat system can be used to serve many zones with dissimilar load characteristics. However, it consumes a constant amount of fan energy, and the heat added to meet the part-load requirements of a zone increases the cooling load. This can result in a nearly constant load on the cooling coil, even when the building is at part-load conditions. Therefore, reheating air that has been previously cooled, in order to respond to part-load conditions, is not very energy efficient and is used only in special constant-volume applications, or when the heat is recovered from another part of the HVAC system.

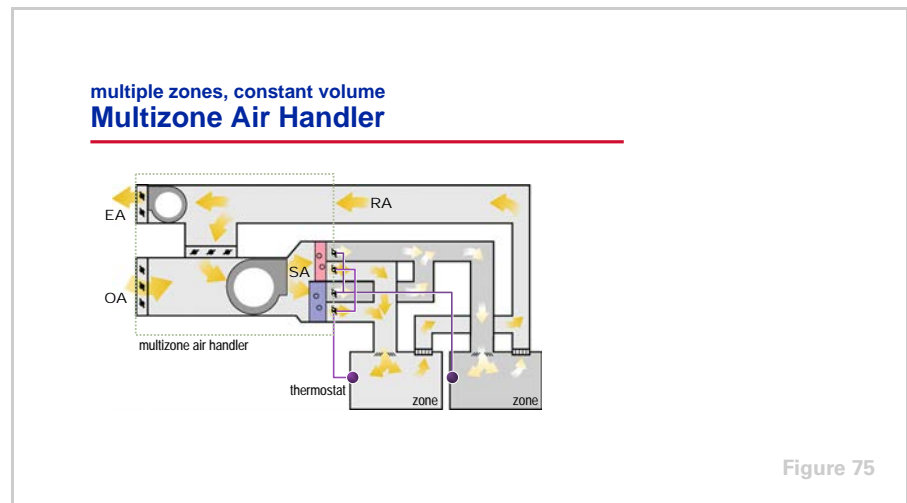

Figure 75 depicts another example of a multiple-zone, constant-volume system. This system, referred to as a **multizone system**, uses a central air handler that contains both a cooling coil and a heating coil, and several pairs of dampers located at the discharge of the air handler. Each pair of “cooling” and “heating” zone dampers is controlled by a thermostat in the zone served by the damper pair. After passing through this pair of dampers, the supply air is delivered to the individual zones through separate, dedicated supply ducts.

At the maximum cooling load for a given zone, the cooling-zone damper is wide open and the heating-zone damper is closed. All of the supply air to be delivered to that zone passes through the central cooling coil. As the cooling

period three

Common HVAC System Types

notes

load in the zone decreases, the cooling-zone damper modulates toward closed and the heating-zone damper modulates toward open. The two airstreams mix to deliver the same quantity of supply air, but at a warmer supply-air temperature to offset the cooling load of the zone without overcooling. At the maximum heating load for the zone, the cooling-zone damper is closed and the heating-zone damper is wide open. All of the supply air passes through the heating coil.

Like the terminal reheat system, the multizone system consumes a constant amount of fan energy, and uses cooling and heating energy simultaneously. Therefore, it is not very energy efficient and is not as commonly used as it was in the past. In fact, these systems are prohibited by some local energy codes or standards.

A variation of this concept is a **three-deck multizone system**. In addition to the cooling and heating airstreams, this system adds a third airstream that is unconditioned, recirculated air. The discharge end of the air handler now has three dampers for each zone. At partial cooling loads, the cooling-zone damper modulates toward closed and the “recirculation” zone damper modulates toward open. The supply air is a mixture of cold air and unconditioned, recirculated air. The heating-zone damper remains closed until the cooling-zone damper is completely closed. At that time, the heating-zone damper modulates toward open and the recirculation-zone damper modulates toward closed. While this system still consumes a constant amount of fan energy, it significantly reduces the mixing of previously cooled and previously heated airstreams.

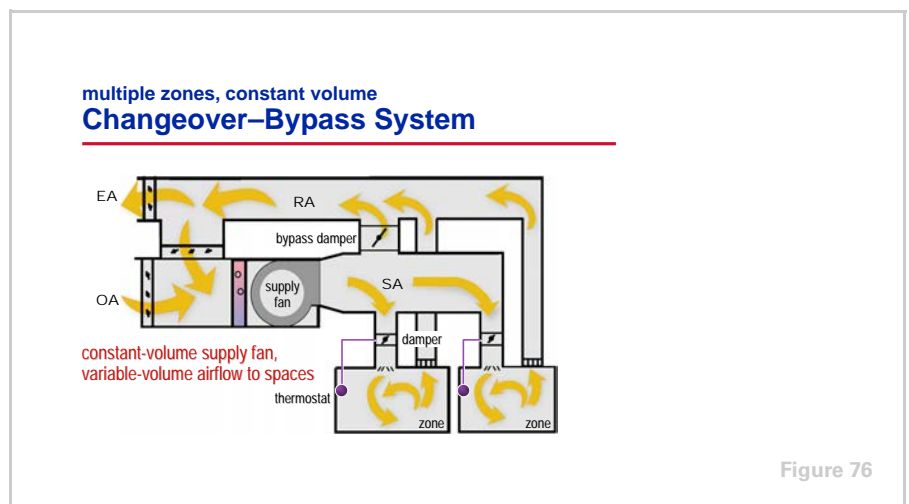

As mentioned earlier, if a zone is comprised of multiple spaces, one drawback of a single-zone system is that the space with the thermostat dictates the cooling or heating capacity of the system. All other spaces must accept the resulting degree of comfort based on that one space. Many smaller buildings, however, cannot afford to install a large number of single-zone units or a more-advanced multiple-zone system. An economical alternative may be to use a

period three

Common HVAC System Types

notes

changeover-bypass system, which uses traditional, single-zone HVAC equipment, but allows independent control for multiple zones.

A changeover-bypass system includes an airflow modulation device, typically a rotating blade damper, for each individually controlled zone. This device modulates supply airflow delivered to the zone in response to the thermostat. Instead of modulating the central supply fan, however, this system delivers a constant quantity of supply air. Any unneeded air is diverted, through a bypass damper and duct, to the return airstream.

The term “changeover” refers to how this system handles the cooling and heating requirements of the building. During the cooling season, the supply air is delivered at a constant cold temperature. During the heating season, this system “changes over” and the supply air is delivered at a constant hot temperature.

At part-load conditions, any air not needed by the zones is diverted through a separate bypass damper into the return airstream. During the cooling season, as more supply air is bypassed, the mixture of cold supply air and warm return air reduces the cooling energy consumption. During the heating season, the mixture of hot supply air and cooler return air reduces the heating energy consumption. However, due to the supply fan providing a constant airflow, no fan energy savings is realized at part-load conditions.

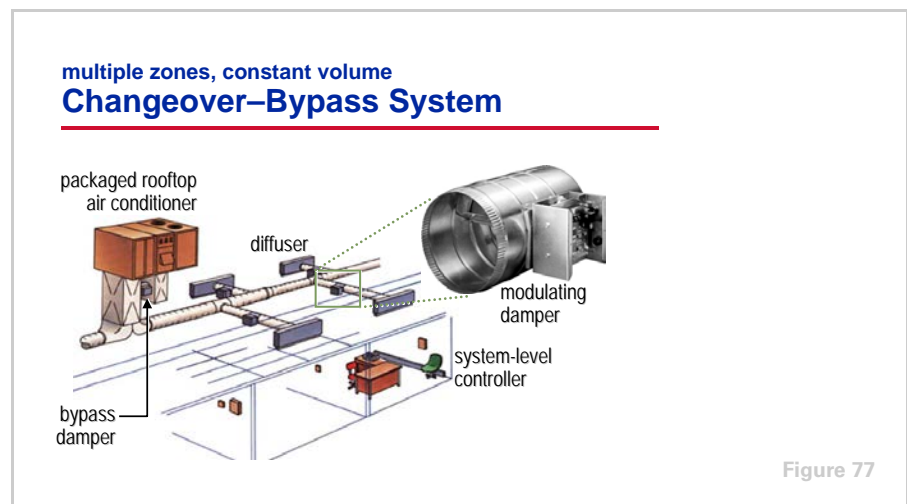

Most changeover-bypass systems use a small, packaged DX rooftop unit to provide cooling and heating. In Figure 77, a packaged DX rooftop unit delivers a constant volume of conditioned supply air to multiple, individually controlled zones. In response to the varying load, a thermostat in each zone instructs the modulating damper to vary the quantity of supply air delivered to that zone. The bypass duct also contains a damper that is modulated to prevent too much supply air from bypassing to the return airstream.

A system-level controller is required to monitor the heating and cooling needs of the zones, and to automatically change the operation of the rooftop unit from heating to cooling, as necessary, to satisfy the needs of the thermal zones.

period three

Common HVAC System Types

notes

A changeover–bypass system cannot accommodate a demand for simultaneous cooling and heating, because the HVAC unit operates in either the cooling mode or the heating mode. Therefore, all of the zones served by a single HVAC unit should have similar thermal load characteristics, minimizing the hours when heating is required in some zones and cooling is simultaneously required in others. For systems where heat may be required when the HVAC unit is operating in the cooling mode, heating coils can be installed in the supply ductwork and controlled by the thermostat.

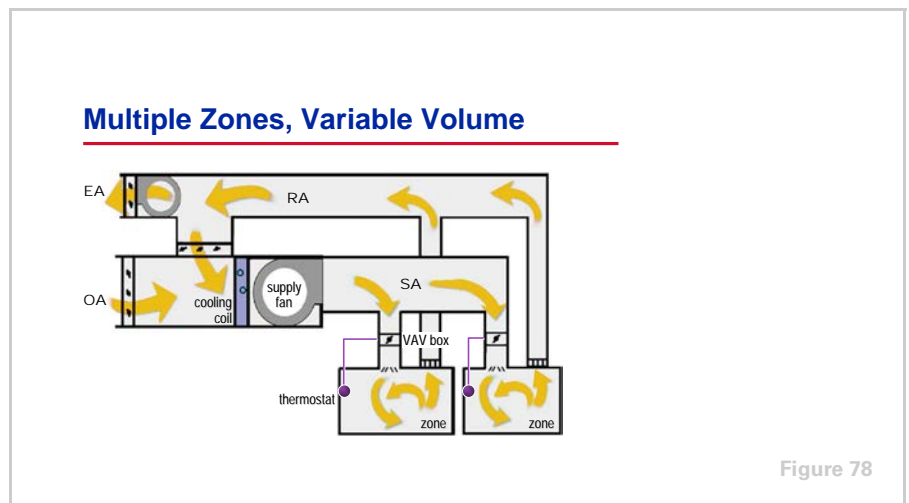

A **multiple-zone, variable-volume (VAV) system** consists of a central air handler that serves several individually controlled zones. Each zone has a VAV terminal unit (VAV box) that is controlled by a thermostat in the zone.

Unlike a constant-volume system, which delivers a constant amount of air at varying temperatures, a VAV system delivers varying amounts of constant-temperature air. A thermostat in each zone compares the dry-bulb temperature to a setpoint, and the VAV terminal responds by modulating the volume of supply air to match the changing cooling load in the zone. Meanwhile, the central supply fan modulates to maintain a constant pressure in the supply ductwork, and cooling capacity is modulated to maintain a constant supply-air temperature.

Heating can be accomplished in several ways. The first approach is to install a heating coil (hot water, steam, or electric) or a gas-fired burner in the central air handler. In this configuration, the system can operate similarly to the changeover–bypass system and switch to delivering warm supply air during the heating season. A second approach is to install individual heating coils inside the VAV terminal units. Each coil is controlled by the zone thermostat to warm up the supply air when necessary. A third approach is to install perimeter baseboard radiant heat within the zone, which can also be controlled by the thermostat.

period three

Common HVAC System Types

notes

Multiple-zone VAV systems are popular because they easily accommodate multiple control zones and help minimize energy use. At part-load conditions, the capacity of the supply fan is reduced to save energy.

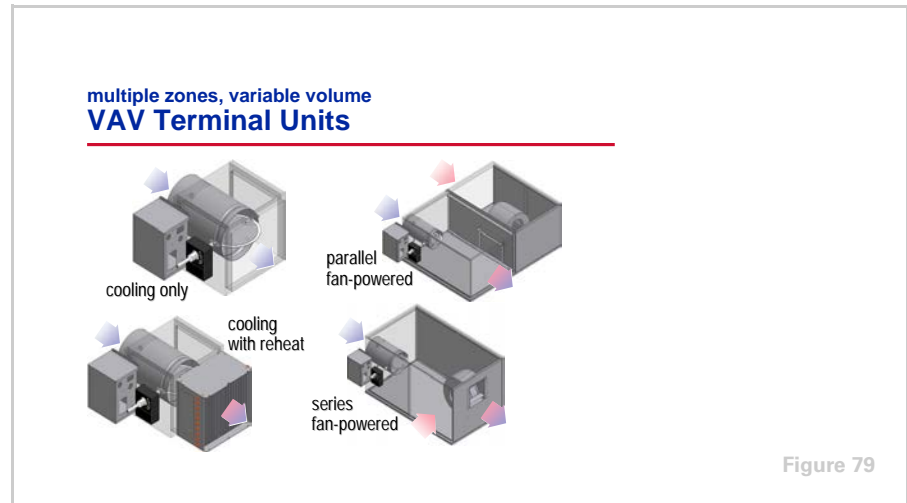

Figure 79

There are several types of VAV terminal units. The **cooling-only VAV terminal unit** consists of an airflow-modulation device with controls packaged inside a sheet-metal enclosure. This VAV terminal unit can modulate the supply airflow to the zone, and is typically used for those zones that require year-round cooling, like the interior zones of a building. If necessary, however, heat can be provided by a remote source, such as baseboard radiation along the wall, and controlled by the VAV terminal unit controller.

The **VAV reheat terminal unit** also contains an airflow-modulation device and controls, but it has an electric or hot-water heating coil added to the discharge of the terminal unit. The heating coil is turned on when the supply airflow has been reduced to a minimum setting. This VAV terminal unit is typically used for those zones that require seasonal cooling and heating, such as perimeter zones of a building, or zones that have widely varying loads, such as conference rooms.

Fan-powered VAV terminal units include a small fan packaged inside the sheet-metal enclosure to mix warm air from the ceiling plenum with cool primary air from the central air handler, in order to offset heating loads in the zone. A heating coil can be added to the discharge of the terminal unit and turned on when the primary airflow has been reduced to a minimum setting.

The **parallel fan-powered VAV terminal unit** has a small fan configured inside the terminal unit to provide parallel airflow paths. The terminal-unit fan cycles on only when the zone requires heating. The fan draws warm air from the ceiling plenum to raise the temperature of the air supplied to the zone.

The **series fan-powered VAV terminal unit** has the fan configured inside the terminal unit so the airflow paths are in series. The terminal-unit fan operates continuously whenever the zone is occupied, and draws air from either the primary air stream or the ceiling plenum, based on the cooling or heating

period three

Common HVAC System Types

notes

requirement of the zone. This results in a constant volume of supply air delivered to the zone at all times.

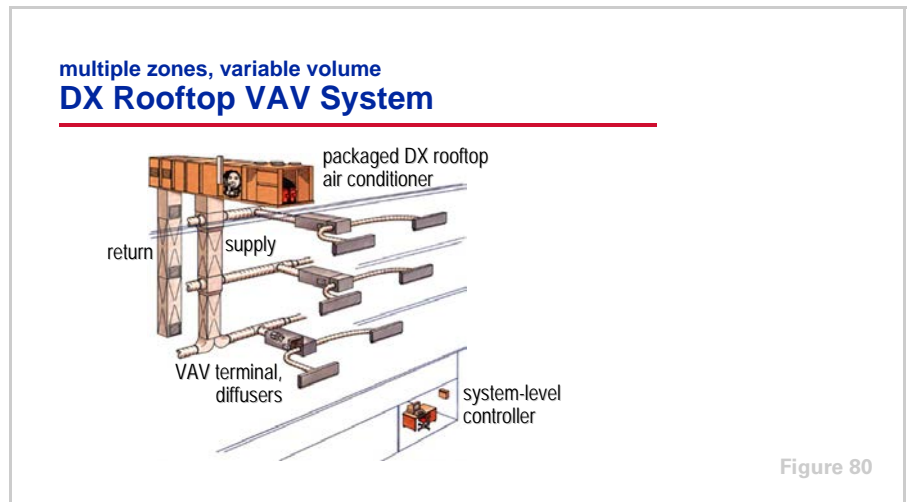

The first example of a multiple-zone, variable-volume system is the **packaged rooftop VAV system**, shown in Figure 80. A large, packaged DX rooftop unit is located outdoors and contains several components of the airside loop, as well as all the components of the refrigeration and heat-rejection loops. A building may use a single rooftop unit or several units, depending on its size, load characteristics, and function.

Supply air is discharged from the unit and travels down a central supply shaft before being distributed through the ductwork that is located in the ceiling plenum above each floor. The supply ductwork delivers air to the VAV terminal units. Each VAV terminal unit is controlled by a thermostat in the zone it serves, and varies the quantity of air delivered to that zone. Air returns from the zones through the open ceiling plenum and travels up a central return shaft to the rooftop unit.

In this example, heating is provided by electric heating coils that are located at the discharge of each VAV terminal unit. A system-level controller ties the unit controllers on each of the VAV terminal units to the controller on the packaged rooftop unit.

period three

Common HVAC System Types

notes

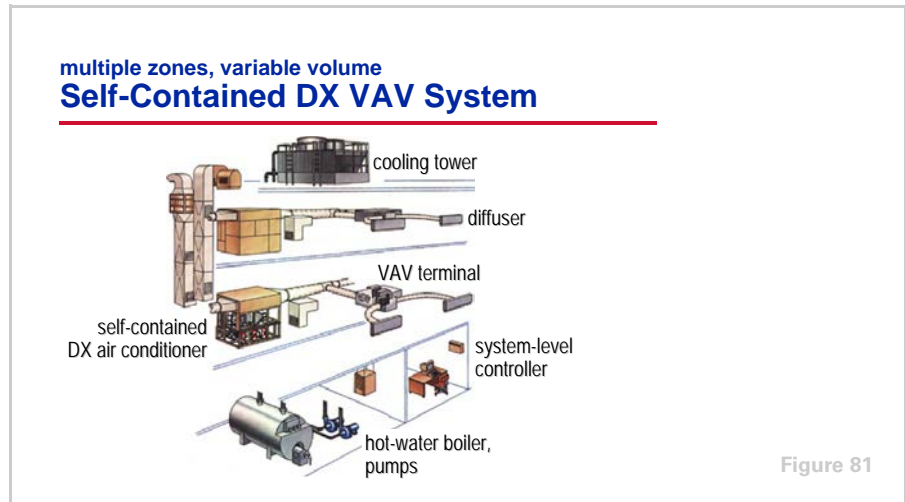

A second example of a multiple-zone VAV system (Figure 81) is the **packaged, self-contained VAV system**. Similar to a packaged rooftop unit, a packaged, self-contained DX unit combines several components of the airside loop with all the components of the refrigeration loop and some components of the heat-rejection loop. One or more of these units are typically installed in a small equipment room on each floor of the building.

In this example system, the self-contained DX unit includes a water-cooled condenser, so a cooling tower is located on the roof and condenser-water pumps are located in the basement. The self-contained units are equipped with a variable-volume supply fan, and discharge conditioned supply air into the supply ductwork located in the ceiling plenum above each floor. The supply ductwork is connected to the VAV terminal units that serve each zone. Air returns from the zones through the open ceiling plenum into the small equipment room, where it is drawn back into the self-contained unit.

In this example, heating is provided by a hot-water boiler in the basement and hot-water heating coils located at the discharge of each VAV terminal unit. Again, a system-level controller ties the unit controllers on each of the VAV terminal units to the controllers on the packaged self-contained units. This system-level controller also coordinates the operation of the cooling tower, the pumps, the hot-water boiler, and the central exhaust fan.

period three

Common HVAC System Types

notes

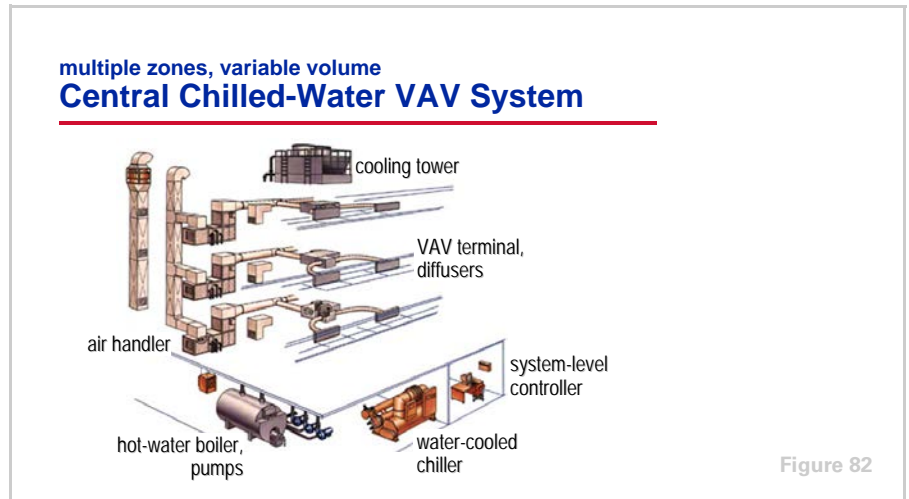

A third example of a multiple-zone VAV system is the **chilled-water VAV system**, shown in Figure 82. In this example, a chilled-water air handler is located in an equipment room on each floor of the building. Each air handler is equipped with a variable-volume supply fan, and discharges conditioned supply air into ductwork located in the ceiling plenum above each floor. The supply ductwork is connected to the VAV terminal units that serve each zone. Air returns from the zones through the open ceiling plenum into the equipment room, where it is drawn back into the air handler.

The chilled water is provided by a water-cooled chiller that is located in the basement, along with the chilled-water and condenser-water pumps. A cooling tower is located on the roof.

In this example, heating is provided by a hot-water boiler in the basement and hot-water heating coils located at the discharge of each VAV terminal unit. Again, a system-level controller ties the unit controllers on each of the VAV terminal units to the controllers on the air handlers, and also coordinates the operation of the chiller, the cooling tower, the pumps, the hot-water boiler, and the central exhaust fan.

period three

Common HVAC System Types

notes

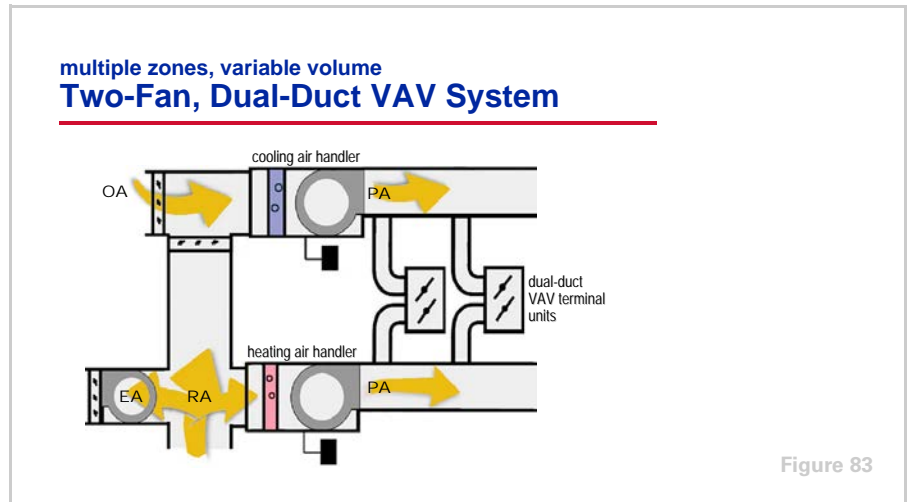

The multiple-zone VAV system introduced earlier used a single supply duct to deliver conditioned supply air to multiple, individually controlled zones. Another type of multiple-zone VAV system is the **dual-duct VAV system**. As its name implies, this system consists of two independent supply-duct systems, shown in Figure 83.

Inside the “cooling” air handler, a portion of the recirculated return air is mixed with outdoor air for ventilation. This mixture is then cooled and delivered as cold primary air through the “cold” supply-duct system to one of the airflow-modulation devices in each dual-duct VAV terminal unit.

Inside the “heating” air handler, the remainder of the recirculated return air is heated, and delivered as warm primary airflow through the “hot” supply-duct system to the other airflow-modulation device in each dual-duct VAV terminal unit.

period three

Common HVAC System Types

notes

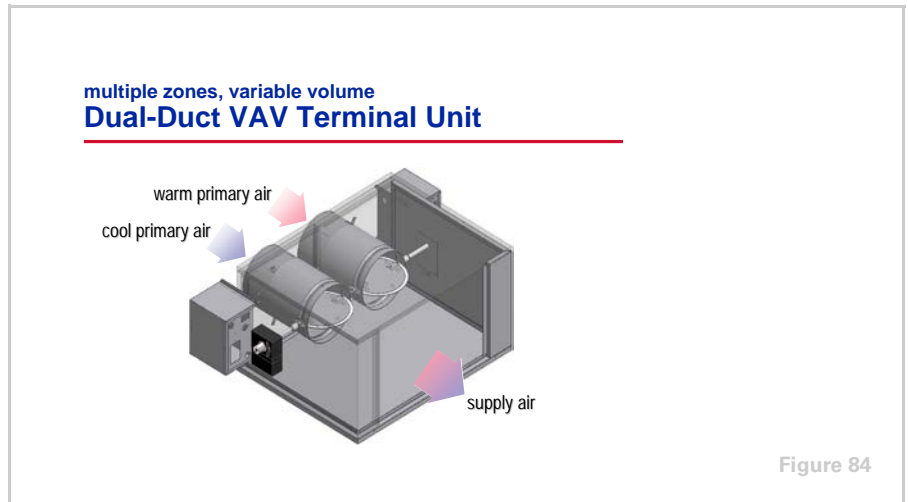

A dual-duct VAV terminal unit consists of two airflow-modulation devices, along with controls, packaged inside a sheet-metal enclosure. Refer to Figure 84. One modulation device varies the amount of cold primary air and the other varies the amount of warm primary air. These two air streams mix inside the dual-duct unit before proceeding downstream to the zone. A dual-duct VAV terminal unit can be controlled to provide either a variable volume or a constant volume of supply air to the zone.

Dual-duct VAV systems are intended for buildings that require seasonal cooling and heating. The energy cost of this system is generally low, and it can provide excellent control of both temperature and humidity. However, it is relatively uncommon because of the high first cost associated with installing two separate duct systems.

period four

Factors That Affect Selection of the HVAC System

notes

Introduction to HVAC Systems

period four

Factors that Affect Selection of the HVAC System

Figure 85

Of all the decisions made by owners, architects, engineers, and contractors during the design and construction phases of a building, the selection of the HVAC system tends to be a decision that is often revisited throughout the life of the building. The building may be an architectural wonder, with state-of-the-art lighting, easy access, fast elevators, lots of parking, the finest furnishings, and superior energy efficiency, but if there are comfort problems, all of the positives seem to go unnoticed.

When it comes to the selection of the HVAC system for a given building, what factors influence the decision? This period will introduce eight of the most-common factors that influence the selection of the HVAC system.

Preference of Building Owner



- **Owner**
 - ◆ Occupies building
- **Developer**
 - ◆ Leases to tenants
 - ◆ May sell building soon after construction

Figure 86

Preference of Building Owner

The individual or entity that decides to build, expand, or renovate a building may actually own and occupy the facility, or may be a developer whose

period four

Factors That Affect Selection of the HVAC System

notes

business is to lease and/or sell the building. Some owners and developers have preferences toward certain HVAC systems, possibly based on past experience.

It is important to note that the motivations affecting building decisions often differ between an owner and a developer. This doesn't mean that what is important to an owner is not important to a developer, but rather that each has different priorities when approaching a building project.

If an owner will occupy the building, life-cycle cost, maintenance cost, system reliability, and a productive work environment may be emphasized in the decision-making process. The selection of the HVAC system becomes more personal when the owner has to work or live in the building.

A developer typically has two motivations. First is the financial performance of the project. Second is the ability to attract and retain tenants. These concerns are related because the financial success of a project depends on the developer's ability to market the building to prospective tenants, who are often the only source of operating income. Some developers may sell the property quickly, either upon completion of construction or within one to three years. For this reason, first cost, building marketability, ability to bill individual tenants for energy use, and flexible work space may be most important to them.



Available Construction Budget

The available budget for purchasing and installing the HVAC system may be imposed on the design team by the owner or developer, or it may be developed with the aid of the design team.

If the owner or developer has predetermined what money is available to construct the building, then the design team is challenged to provide an HVAC system that meets the requirements of the building with the available money. This is not always easy to do! Often, some requirements are sacrificed along the way because the stated requirements do not match the available budget to meet those requirements.

period four

Factors That Affect Selection of the HVAC System

notes

Size and Shape of Building



Figure 88

Size and Shape of Building

The building size and shape can quickly narrow down the available HVAC system choices. High-rise buildings are not often well-suited for packaged DX rooftop equipment because of the long distances that the air must be transported. In split DX systems, the allowable distance between the components of the refrigeration loop is limited to ensure reliable operation. Chilled-water systems, however, are ideal for applications where the refrigeration equipment is centrally located within a building, or among a campus of buildings, and the cooling loads are remote.

The desired location of HVAC equipment within the building can also impact the selection. If the owner or developer does not want equipment located outdoors, it can be located in basements, in penthouses, or in equipment rooms for each floor. If there is limited space inside the building, the HVAC system may be located on the roof, in a separate building alongside the main building, or even at a remote location.

period four

Factors That Affect Selection of the HVAC System

notes

Function of Building

- **Comfort requirements**
 - ◆ Temperature
 - ◆ Humidity
 - ◆ Air movement
 - ◆ Fresh air
 - ◆ Clean air
 - ◆ Noise levels
- **Number of tenants**
- **After-hours usage**



Figure 89

Function of Building

How will the building be used? Several comfort requirements were introduced in Period One. These requirements may be different from one building to the next, or may be prioritized differently due to differing building functions. For example, desired background-noise levels are much different in a classroom than they are in a manufacturing assembly area. And humidity-control requirements are much different in a supermarket than they are in an office building. If the comfort requirements for the project are considered in advance and planned for, then an HVAC system can be selected and designed to meet those requirements. When one or more of these requirements are unknown or ignored, the finger pointing typically begins.

If the building will have multiple tenants, can the HVAC system accommodate differing requirements between tenants? Is the interior layout expected to change in the future? How many zones should the building have? Do occupants require after-hours use of the HVAC system, and who is paying the energy bill—the tenants or the building owner? The answers to these questions may determine whether the system uses individual HVAC units or a central system with a building automation system that can track energy usage by tenant.

period four

Factors That Affect Selection of the HVAC System

notes



Figure 90

Architectural Limitations

The thousands of different components that make up a building must all fit together in a coordinated way. Many buildings are designed to make an architectural statement. It may be hard to make that statement with a cooling tower on the front lawn or packaged DX units in every window. However, there are creative ways to conceal equipment for aesthetic reasons.

Unlike the example in Figure 90, the floor-to-floor height is generally squeezed as tight as possible to reduce construction costs, or in the case of taller buildings, to get as many floors in the building as possible. This results in limited space in the ceiling plenum. This can be particularly challenging for a central air-handling system, and may result in the use of a system, such as chilled-water terminal units or water-source heat pumps, where the equipment is located closer to each zone.

Sometimes, building trades can influence the type of HVAC system installed. In some geographical regions, sheet-metal trades prefer to install “dry” systems, that is, systems with central equipment rooms that duct supply air throughout the building. In other regions, plumbing trades prefer to install “wet” systems with piping that runs throughout the building.

period four

Factors That Affect Selection of the HVAC System

notes

Life-Cycle Cost



- Installation
- Energy (operation)
- Maintenance
- Replacement

Figure 91

Life-Cycle Cost

Decisions made solely, or primarily, on installed (first) cost often ignore such factors as energy use, maintenance requirements, or expected life. Life-cycle cost includes the total cost of owning and operating the HVAC system over a given period of years. This includes installed cost, energy cost, maintenance cost, replacement cost, and any other known and expected costs. As could be expected, some HVAC systems use more energy than others. Software tools are available to help the HVAC system designer analyze various HVAC systems based on life-cycle cost.

In addition, many state and local building codes include requirements for energy efficiency. Some requirements relate to the efficiency of various components, such as packaged DX rooftop units or water chillers, and some requirements relate to the design and control of the entire system. Some of these requirements even prohibit the use of certain types of HVAC systems for certain applications.

period four

Factors That Affect Selection of the HVAC System

notes

Ease of Operation and Maintenance



Figure 92

Ease of Operation and Maintenance

Will there be building personnel on site to operate and maintain the HVAC system? What level of training is required to operate the system? If the building will not have someone on-site to operate or maintain the HVAC system, this will impact the system choice. Most types of HVAC systems have some level of automatic control. The use of communicating building automation systems (BAS) has made this less of a concern, because the operator can be located off-site and still diagnose the cause of a problem, just as if he or she were inside the building.

Additionally, some local or state codes require an on-site building operator for certain types of systems. Some of these requirements are based on the capacity of the HVAC equipment. For certain building types, this type of code requirement may cause the selection of a system that uses several smaller pieces of equipment, rather than a few large pieces of equipment.

period four

Factors That Affect Selection of the HVAC System

notes



Figure 93

Time Available for Construction

The speed with which a building must be built or renovated, and when the HVAC equipment must be installed during that process, can also influence the selection of the HVAC system. Some types of HVAC equipment are made-to-order and have lead times for manufacturing. For this reason, equipment that is in stock may be selected for a fast-track building project. Packaged equipment with factory-installed controls is often selected because it can often be installed and commissioned very quickly.

Analyzing and evaluating the many system choices can consume a great deal of engineering time. For this reason, it is imperative that the HVAC system design engineer become involved early in the design process. Often, the project schedule does not allow sufficient time for the design team to properly evaluate HVAC system alternatives. There is a great deal of pressure to finalize the system choice quickly, and design decisions are often made because "that's what we did last time." The owner, developer, or architect is frequently better served by the added engineering costs required to analyze system options carefully, and then to integrate the HVAC system into architectural design.

period five

Review

notes

Introduction to HVAC Systems

period five
Review

Figure 94

We will now review the main concepts that were covered in this clinic.

Review—Period One

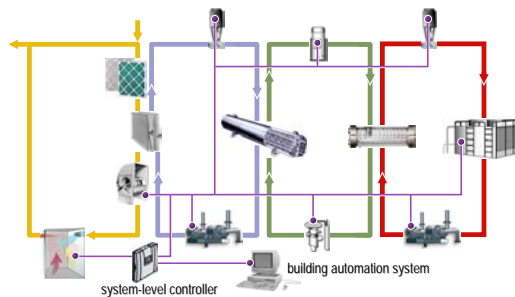

Figure 95

Period One introduced five loops (or subsystems) that can be used to describe an HVAC system and understand its components. These loops are:

- Airside loop (yellow)
- Chilled-water loop (blue)
- Refrigeration loop (green)
- Heat-rejection loop (red)
- Controls loop (purple)

While these five loops can be used to describe virtually any HVAC system, not every system uses all five loops.

period five

Review

notes

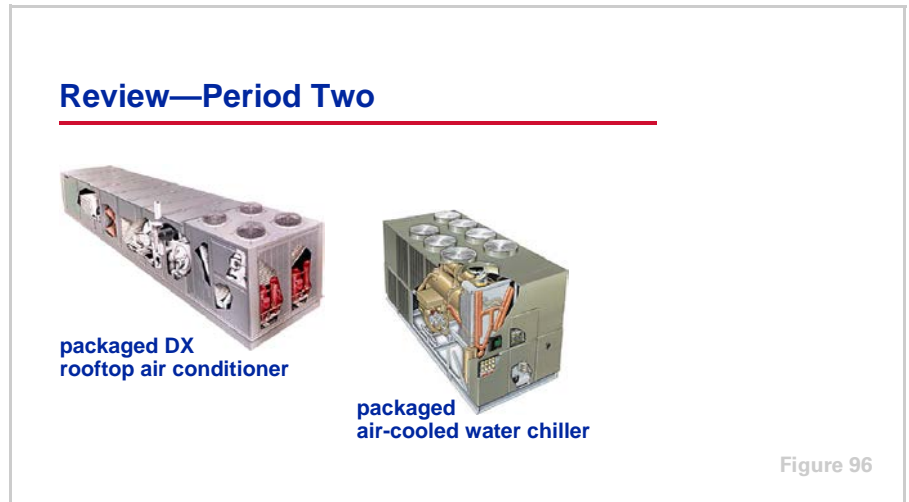

Period Two discussed the differences between direct-expansion (DX) and chilled-water systems. DX systems have cold liquid refrigerant flowing directly through the tubes of the cooling coil. Chilled-water systems have cold water flowing through the coil. The primary difference between these two types of systems is the presence of the chilled-water loop. The chilled-water loop transports heat energy between the airside loop and the refrigeration loop. As described in Period One, it is comprised primarily of a cooling coil, a circulating pump, an evaporator, a control valve, and interconnecting piping.

In either system, the components of the refrigeration loop can be either packaged in the factory by the manufacturer or manufactured separately (split) and assembled in the field. Figure 96 shows two examples of packaged equipment: a packaged, DX rooftop unit and a packaged, air-cooled water chiller.

Period Two also discussed some of the factors that affect the HVAC system designer's decision whether to use a DX system or a chilled-water system.

period five

Review

notes

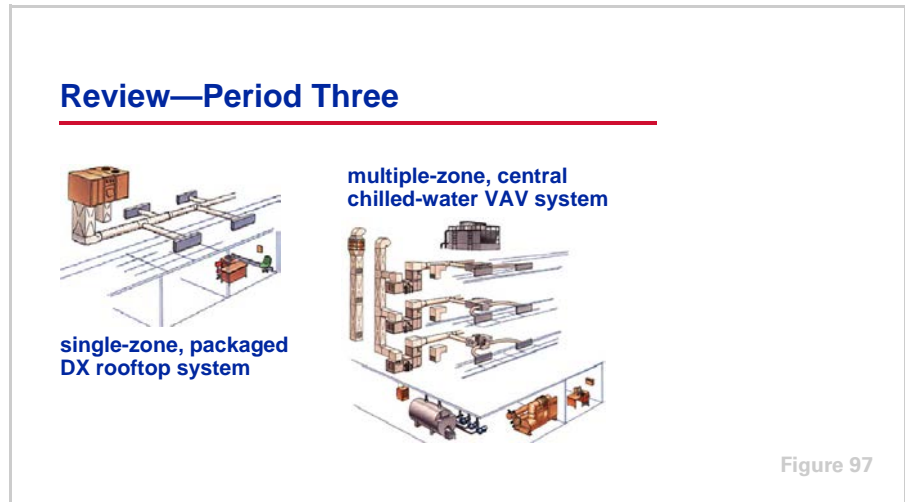

Period Three introduced several common types of HVAC systems. Figure 97 shows two of the systems discussed.

The first is a single-zone, constant-volume system that uses a packaged DX rooftop unit. This unit packages several components of the airside loop, all the components of the refrigeration and heat-rejection loops, and most of the components of the controls loop, inside a common casing. The supply air is discharged from the unit into the supply ductwork and delivered to the conditioned space through supply diffusers.

The second system is a multiple-zone, variable-air-volume (VAV) system that uses a central air handler and a water-cooled chiller. A chilled-water air handler is located in an equipment room on each floor of the building. Supply air is discharged into supply ductwork and delivered to VAV terminal units that serve each zone. The chilled water is provided by a water-cooled chiller that is located in the basement along with the chilled-water and condenser-water pumps. A cooling tower is located on the roof.

period five

Review

notes

Review—Period Four

- Preference of building owner
- Available construction budget
- Size and shape of building
- Function of building (comfort requirements)
- Architectural limitations
- Life-cycle cost
- Ease of operation and maintenance
- Time available for construction

Figure 98

Finally, Period Four discussed eight factors that typically impact the HVAC system design engineer's decision about which type of HVAC system to use for a particular building project. The requirements, and the priority of each requirement relative to the others, are unique for each project, so the right system for one project may be different than the right system for a different project.

period five **Review**

notes



For more information, refer to the following references:

- *Cooling and Heating Load Estimation* Air Conditioning Clinic (Trane literature order number TRG-TRC002-EN)
- *Refrigeration Cycle* Air Conditioning Clinic (TRG-TRC003-EN)
- *Refrigeration Compressors* Air Conditioning Clinic (TRG-TRC004-EN)
- *Refrigeration System Components* Air Conditioning Clinic (TRG-TRC005-EN)
- *VAV Systems* Air Conditioning Clinic (TRG-TRC014-EN)
- *Water-Source Heat Pump Systems* Air Conditioning Clinic (TRG-TRC015-EN)
- *Chilled-Water Systems* Air Conditioning Clinic (TRG-TRC016-EN)
- *HVAC System Control* Air Conditioning Clinic (TRG-TRC018-EN)
- ASHRAE Handbook – HVAC Systems and Equipment

Visit the ASHRAE Bookstore at www.ashrae.org.

For more information on additional educational materials available from Trane, contact your local Trane office (request a copy of the Educational Materials catalog – Trane literature order number EM-ADV1) or visit our online bookstore at www.trane.com/bookstore/.



Quiz

Questions for Period 1

- 1** The condenser can be part of which loop(s)?
 - a** Airside loop
 - b** Chilled-water loop
 - c** Refrigeration loop
 - d** Heat-rejection loop
 - e** Controls loop

- 2** The evaporator can be part of which loop(s)?
 - a** Airside loop
 - b** Chilled-water loop
 - c** Refrigeration loop
 - d** Heat-rejection loop
 - e** Controls loop

Questions for Period 2

- 3** Which loop is eliminated in a direct expansion (DX) system?
 - a** Airside loop
 - b** Chilled-water loop
 - c** Refrigeration loop
 - d** Heat-rejection loop
 - e** Controls loop

- 4** What are some benefits of using a “packaged” piece of cooling equipment rather than a “split” system?

- 5** Which of the following are common reasons for selecting a DX system rather than a chilled-water system?
 - a** In smaller buildings, a DX system frequently has a lower installed cost than a chilled-water system.
 - b** A DX system may require less space indoors than a chilled-water system.
 - c** There is less of a concern about freeze protection in a DX system.
 - d** Refrigerant is easier to transport long distances.

Quiz

- 6** Which of the following are common reasons for selecting a chilled-water system rather than a DX system?
- a** A chilled-water system typically provides more-stable control than a DX system.
 - b** Chilled-water cooling equipment is available in larger-capacity sizes than DX equipment.
 - c** There is less of a concern about freeze protection in a chilled-water system.
 - d** Chilled water is easier to transport long distances.

Questions for Period 3

- 7** Which of the following components are typically found inside the casing of a chilled-water terminal unit?
- a** Supply fan
 - b** Water-cooled condenser
 - c** Filter
 - d** Condenser-water pump
- 8** True or False: In a typical single-zone VAV system, the capacity of the supply fan is modulated in direct response to the thermostat in the conditioned space.
- 9** What is the name of the component in a multiple-zone VAV system that allows the system to vary the airflow delivered to each zone?
- 10** True or False: In a water-source heat-pump (WSHP) system, the refrigeration cycle is reversible, allowing the heat pump to provide either cooling or heating.
- 11** True or False: A changeover-bypass system delivers a variable quantity of air to each zone, but the supply fan delivers a constant quantity of air.
- 12** True or False: A common reason for using a two-pipe system rather than a four-pipe system is because a two-pipe system can provide simultaneous cooling and heating.

Answers

- 1** c and d
- 2** a, b, and c
- 3** b
- 4** The components of the refrigeration equipment are assembled and tested in the factory by the manufacturer. There is no need to install refrigerant piping in the field. Less time is required to install and commission the equipment and controls. Often improves the reliability of the system because less work is required in the field.
- 5** a, b, and c
- 6** a, b, and d
- 7** a and c
- 8** True
- 9** VAV terminal unit
- 10** True
- 11** True
- 12** False

Glossary

air-cooled condenser A type of condenser in which refrigerant flows through the tubes and rejects heat to air that is drawn across the tubes.

building automation system (BAS) A centralized control and monitoring system for a building.

changeover–bypass system A system that allows a variable supply airflow to the spaces but uses a constant-volume central supply fan. This is accomplished by using a large damper to bypass the excess air. This type of system is common in smaller buildings that require individual space comfort control.

chilled-water system A system that uses water as the cooling media. The refrigerant inside the evaporator absorbs heat from the water. This water is pumped to cooling coils in order to absorb heat from the air that is used for space conditioning.

compressor A mechanical device used in the vapor-compression refrigeration cycle to increase the pressure and temperature of the refrigerant vapor.

condenser The component of the refrigeration system in which refrigerant vapor is converted to liquid as it rejects heat to water or air.

constant-volume system A type of air-conditioning system that varies the temperature of a constant volume of air supplied to meet the changing load conditions of the space.

cooling tower A device used to reject the heat from a water-cooled condenser by spraying the condensing water over fill while drawing outdoor air upward through the slats.

dedicated outdoor-air unit An air handler used to cool, heat, dehumidify, or humidify all of the outdoor air brought into the building for ventilation. This conditioned outdoor air may be delivered directly to the conditioned spaces or to other air handlers or terminal equipment.

diffuser A device connected to the end of the supply-duct system, used to distribute the supply air effectively to the conditioned space.

direct expansion (DX) system A system that uses the refrigerant directly as the cooling media. The refrigerant inside the finned-tube evaporator absorbs heat directly from the air used for space conditioning.

drain pan A device positioned under a cooling coil to collect condensate and direct it to a drainage system.

evaporative condenser A type of condenser in which refrigerant flows through the tubes and rejects heat to air that is drawn across the tubes, which are wetted on the outside by circulating water.

evaporator The component of the refrigeration system in which cool, liquid refrigerant absorbs heat from air, water, or some other fluid, causing the refrigerant to boil.

Glossary

exhaust air Air that is removed from the conditioned space(s) and then discharged to the outdoors.

expansion device The component of the refrigeration system used to reduce the pressure and temperature of the refrigerant.

fan-coil unit A piece of HVAC equipment that contains a fan and a finned-tube heat exchanger, factory-assembled within a common casing. A fan coil is typically located within each conditioned space, or in the wall or ceiling near the space.

finned-tube evaporator A type of evaporator in which refrigerant flows through the tubes and air blows across the tubes and fins.

ground-source heat-pump system A type of water-source heat-pump system that takes advantage of the relatively constant temperature of the earth and uses the ground or surface water as the heat rejecter and heat adder.

latent heat Heat that causes a change in the moisture content of the air with no change in dry-bulb temperature.

mixed air A mixture of supply air and recirculated return air.

outdoor air Air brought in to the building from outside the building, either by a ventilation system or through openings provided for natural ventilation.

packaged DX rooftop air conditioner A piece of roof-mounted HVAC equipment that contains a fan, a finned-tube evaporator, all the components of the refrigeration circuit, and possibly a heating section, factory-assembled within a common casing.

packaged terminal air conditioner (PTAC) A piece of HVAC equipment that contains a supply fan, a filter, a finned-tube evaporator coil, a compressor, an air-cooled condenser coil, a condenser fan, an expansion device, and all of the controls, factory-assembled within a common casing.

plenum The space between the ceiling and the roof or floor above.

recirculated return air Air removed from the conditioned space and reused as supply air, usually after passing through an air-cleaning and -conditioning system, for delivery to the conditioned space.

refrigerant A substance used to absorb and transport heat for the purpose of cooling.

return air Air that is removed from the conditioned space(s) and either recirculated or exhausted.

sensible heat Heat that causes a change in the dry-bulb temperature of the air with no change in moisture content.

shell-and-tube evaporator A type of evaporator in which refrigerant flows through the tubes and water fills the surrounding shell.

Glossary

supply air Air that is delivered to the conditioned space by mechanical means for ventilation, heating, cooling, humidification, or dehumidification.

supply duct system A system that is typically constructed of ductwork, fittings, and diffusers. This system transports the supply air from the air-conditioning equipment to the conditioned space.

variable-air-volume (VAV) system A type of air-conditioning system that varies the volume of constant-temperature air supplied to meet the changing load conditions of the space.

variable-speed drive A device used to vary the capacity of a fan, a pump, or a compressor by varying the speed of the motor that rotates the drive shaft.

VAV terminal unit A sheet-metal assembly used to vary the quantity of supply air delivered to the conditioned space.

ventilation The intentional introduction of outdoor air into a space through the use of the HVAC system in the building.

water-cooled condenser A type of condenser in which water flows through the tubes and absorbs heat from the refrigerant that fills the surrounding shell.

water-source heat pump A device that transfers heat from air to water and vice-versa. It includes the basic refrigeration components of a compressor, a condenser, an evaporator, and an expansion device. It can also reverse the refrigeration cycle to perform heating as well as cooling.



Trane optimizes the performance of homes and buildings around the world. A business of Ingersoll Rand, the leader in creating and sustaining safe, comfortable and energy efficient environments, Trane offers a broad portfolio of advanced controls and HVAC systems, comprehensive building services, and parts. For more information, visit www.Trane.com.

Trane has a policy of continuous product and product data improvement and reserves the right to change design and specifications without notice.